

# DIGITAL VIDEO RECORDER 9- AND 16-CHANNEL MODELS USER'S MANUAL

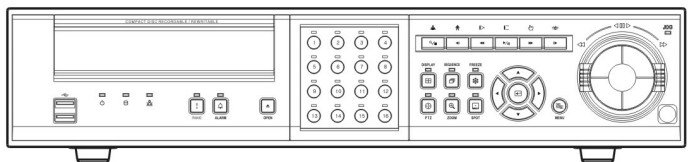





## WARNING

RISK OF ELECTRIC SHOCK  
DO NOT OPEN



**WARNING:** TO REDUCE THE RISK OF ELECTRIC SHOCK,  
DO NOT REMOVE COVER (OR BACK).  
NO USER-SERVICEABLE PARTS INSIDE.  
REFER SERVICING TO QUALIFIED  
SERVICE PERSONNEL.



The lightning flash with arrowhead symbol, within an equilateral triangle, is intended to alert the user to the presence of uninsulated "dangerous voltage" within the product's enclosure that may be of sufficient magnitude to constitute a risk of electric shock.



The exclamation point within an equilateral triangle is intended to alert the user to the presence of important operating and maintenance (servicing) instructions in the literature accompanying the appliance.

### COMPLIANCE NOTICE OF FCC:

THIS EQUIPMENT HAS BEEN TESTED AND FOUND TO COMPLY WITH THE LIMITS FOR A CLASS A DIGITAL DEVICE, PURSUANT TO PART 15 OF THE FCC RULES. THESE LIMITS ARE DESIGNED TO PROVIDE REASONABLE PROTECTION AGAINST HARMFUL INTERFERENCE WHEN THE EQUIPMENT IS OPERATED IN A COMMERCIAL ENVIRONMENT. THIS EQUIPMENT GENERATES, USES, AND CAN RADIATE RADIO FREQUENCY ENERGY AND IF NOT INSTALLED AND USED IN ACCORDANCE WITH THE INSTRUCTION MANUAL, MAY CAUSE HARMFUL INTERFERENCE TO RADIO COMMUNICATIONS. OPERATION OF THIS EQUIPMENT IN A RESIDENTIAL AREA IS LIKELY TO CAUSE HARMFUL INTERFERENCE, IN WHICH CASE USERS WILL BE REQUIRED TO CORRECT THE INTERFERENCE AT THEIR OWN EXPENSE.

**WARNING:** CHANGES OR MODIFICATIONS NOT EXPRESSLY APPROVED BY THE PARTY RESPONSIBLE FOR COMPLIANCE COULD VOID THE USER'S AUTHORITY TO OPERATE THE EQUIPMENT.

THIS CLASS OF DIGITAL APPARATUS MEETS ALL REQUIREMENTS OF THE CANADIAN INTERFERENCE-CAUSING EQUIPMENT REGULATIONS.

The information in this manual is believed to be accurate as of the date of publication. Pacific Communications is not responsible for any problems resulting from the use thereof. The information contained herein is subject to change without notice. Revisions or new editions to this publication may be issued to incorporate such changes.

# Important Safeguards

**1. Read Instructions**

All the safety and operating instructions should be read before the appliance is operated.

**2. Retain Instructions**

The safety and operating instructions should be retained for future reference.

**3. Cleaning**

Unplug this equipment from the wall outlet before cleaning it. Do not use liquid aerosol cleaners. Use a damp soft cloth for cleaning.

**4. Attachments**

Never add any attachments and/or equipment without the approval of the manufacturer as such additions may result in the risk of fire, electric shock or other personal injury.

**5. Water and/or Moisture**

Do not use this equipment near water or in contact with water.

**6. Accessories**

Do not place this equipment on an unstable cart, stand or table. The equipment may fall, causing serious injury to a child or adult, and serious damage to the equipment. Wall or shelf mounting should follow the manufacturer's instructions, and should use a mounting kit approved by the manufacturer.



This equipment and cart combination should be moved with care. Quick stops, excessive force, and uneven surfaces may cause the equipment and cart combination to overturn.

**7. Power Sources**

This equipment should be operated only from the type of power source indicated on the marking label. If you are not sure of the type of power, please consult your equipment dealer or local power company.

**8. Power Cords**

Operator or installer must remove power and TNT connections before handling the equipment.

**9. Lightning**

For added protection for this equipment during a lightning storm, or when it is left unattended and unused for long periods of time, unplug it from the wall outlet and disconnect the antenna or cable system. This will prevent damage to the equipment due to lightning and power-line surges.

**10. Overloading**

Do not overload wall outlets and extension cords as this can result in the risk of fire or electric shock.

**11. Objects and Liquids**

Never push objects of any kind through openings of this equipment as they may touch dangerous voltage points or short out parts that could result in a fire or electric shock. Never spill liquid of any kind on the equipment.

**12. Servicing**

Do not attempt to service this equipment yourself. Refer all servicing to qualified service personnel.

**13. Damage requiring Service**

Unplug this equipment from the wall outlet and refer servicing to qualified service personnel under the following conditions:

- A. When the power-supply cord or the plug has been damaged.
- B. If liquid is spilled, or objects have fallen into the equipment.
- C. If the equipment has been exposed to rain or water.
- D. If the equipment does not operate normally by following the operating instructions, adjust only those controls that are covered by the operating instructions as an improper adjustment of other controls may result in damage and will often require extensive work by a qualified technician to restore the equipment to its normal operation.
- E. If the equipment has been dropped, or the cabinet damaged.
- F. When the equipment exhibits a distinct change in performance — this indicates a need for service.

**14. Replacement Parts**

When replacement parts are required, be sure the service technician has used replacement parts specified by the manufacturer or that have the same characteristics as the original part. Unauthorized substitutions may result in fire, electric shock or other hazards.

**15. Safety Check**

Upon completion of any service or repairs to this equipment, ask the service technician to perform safety checks to determine that the equipment is in proper operating condition.

**16. Field Installation**

This installation should be made by a qualified service person and should conform to all local codes.

**17. Correct Batteries**

Warning: Risk of explosion if battery is replaced by an incorrect type. Dispose of used batteries according to the instructions.

**18. Tmra**

A manufacturer's maximum recommended ambient temperature (Tmra) for the equipment must be specified so that the customer and installer may determine a suitable maximum operating environment for the equipment.

**19. Elevated Operating Ambient Temperature**

If installed in a closed or multi-unit rack assembly, the operating ambient temperature of the rack environment may be greater than room ambient. Therefore, consideration should be given to installing the equipment in an environment compatible with the manufacturer's maximum rated ambient temperature (Tmra).

**20. Reduced Air Flow**

Installation of the equipment in the rack should be such that the amount of airflow required for safe operation of the equipment is not compromised.

**21. Mechanical Loading**

Mounting of the equipment in the rack should be such that a hazardous condition is not caused by uneven mechanical loading.

**22. Circuit Overloading**

Consideration should be given to connection of the equipment to supply circuit and the effect that overloading of circuits might have on over current protection and supply wiring. Appropriate consideration of equipment nameplate ratings should be used when addressing this concern.

**23. Reliable Earthing (Grounding)**

Reliable grounding of rack mounted equipment should be maintained. Particular attention should be given to supply connections other than direct connections to the branch circuit (e.g., use of power strips).

# Table of Contents

<b>Chapter 1 — Introduction</b> .....	1
<b>Features</b> .....	1
<b>Technical Overview</b> .....	1
<b>Chapter 2 — Installation</b> .....	3
<b>Package Contents</b> .....	3
<b>Required Installation Tools</b> .....	3
<b>Connecting the Video Input</b> .....	4
<b>Connecting the Loop-Through Video</b> .....	4
<b>Connecting the Monitor</b> .....	4
<b>Connecting a Computer VGA Monitor</b> .....	5
<b>Connecting Audio</b> .....	5
<b>Connecting Alarms</b> .....	5
AI 1 to 16 (Alarm-In) .....	6
GND (Ground) .....	6
AO 1 to 16 (Alarm-Out) .....	6
ARI (Alarm Reset In) .....	6
<b>Connecting RS485</b> .....	7
<b>Connecting to the USB Ports</b> .....	7
<b>Connecting to the RS232 Port</b> .....	8
<b>Connecting to the Ultra Wide SCSI Port</b> .....	8
<b>Connecting to the Network Port</b> .....	9
<b>Factory Reset</b> .....	9
<b>Connecting the Power Cord</b> .....	10
<b>Chapter 3 — Configuration</b> .....	11
<b>Front Panel Controls</b> .....	11
POWER LED .....	12
HDD LED .....	12
NETWORK LED .....	12
Camera Buttons (1 to 16) .....	12
PANIC Button .....	13
ALARM Button .....	13
SEARCH/STOP Button .....	13
BACKWARD Button .....	13
RW (Rewind) Button .....	13
PLAY/PAUSE Button .....	13
FF (Fast Forward) Button .....	13
FORWARD Button .....	14
DISPLAY Button .....	14

SEQUENCE Button .....	14
FREEZE Button .....	14
PTZ Button.....	14
ZOOM Button.....	14
SPOT Button.....	14
Enter Button.....	14
Up, Down, Left, Right Arrow Buttons .....	15
MENU Button.....	15
Shuttle Ring .....	15
Jog Dial.....	15
ID Button on Remote Control.....	16
<b>Turning on the Power</b> .....	16
<b>Initial Unit Setup</b> .....	16
<b>Setup Screen</b> .....	17
System Information.....	18
Date/Time Setup.....	21
Storage Screen.....	23
User Setup Screen .....	26
Shutdown Screen .....	29
Logout Screen .....	29
<b>Network &amp; Notification Setup</b> .....	30
Network Screen .....	30
LAN Setup Screen .....	31
Modem Setup .....	34
DVRNS Setup.....	35
Notification Setup.....	37
<b>Configuring Devices</b> .....	39
Camera Setup Screen .....	39
Audio Setup Screen.....	41
Alarm-Out Screen .....	42
Display Screen.....	44
Remote Control Screen .....	47
<b>Recording Settings</b> .....	48
Record Screen.....	48
Schedule Screen .....	49
Pre-Event Screen .....	51
Archive Screen .....	52
<b>Event Settings</b> .....	53
Alarm-In Screen.....	54
Motion Detection Screen.....	56
Video Loss Screen.....	59
Text-In Screen .....	61

System Event Screen .....	65
Event Status Screen .....	67
<b>Chapter 4 — Operation .....</b>	<b>69</b>
<b>Turning on the Power .....</b>	<b>69</b>
<b>Live Monitoring.....</b>	<b>69</b>
Active Cameo Mode .....	70
PIP Mode .....	70
Zoom Mode.....	71
PTZ Mode .....	71
Image Adjustment.....	73
<b>Event Monitoring .....</b>	<b>74</b>
<b>Covert Camera.....</b>	<b>74</b>
<b>Spot Monitoring.....</b>	<b>75</b>
<b>Using a Mouse .....</b>	<b>76</b>
<b>Recording Video.....</b>	<b>77</b>
<b>Recording Audio .....</b>	<b>78</b>
<b>Playing Recorded Video .....</b>	<b>78</b>
RW (Rewind) Button .....	78
FF (Fast Forward) Button.....	79
BACKWARD Button.....	79
FORWARD Button.....	79
SEARCH/STOP Button.....	79
Camera Buttons (1 to 16).....	79
DISPLAY Button .....	79
ZOOM Button.....	79
Shuttle Ring .....	79
Jog Dial.....	80
<b>Searching Video .....</b>	<b>81</b>
Go to the Date/Time .....	82
Calendar Search.....	82
Event Log Search .....	83
Text-In Search .....	86
Motion Search.....	88
Clip-Copy Screen.....	90
Print Screen .....	92
<b>Appendix A — USB Hard Disk Drive Preparation .....</b>	<b>93</b>
<b>Preparing the USB-IDE hard disk drive in Windows 2000 .....</b>	<b>93</b>
<b>Preparing the USB-IDE hard disk drive in Windows 98 .....</b>	<b>94</b>
<b>Appendix B — Reviewing Video Clips .....</b>	<b>95</b>

<b>Appendix C — Troubleshooting .....</b>	<b>98</b>
<b>Appendix D — Connector Pin Outs .....</b>	<b>99</b>
<b>I/O Connector Pin Outs .....</b>	<b>99</b>
<b>RS485 Connector Pin Outs .....</b>	<b>99</b>
<b>Appendix E — Map of Screens .....</b>	<b>100</b>
<b>Appendix F — System Log Notices .....</b>	<b>101</b>
<b>Appendix G — Error Code Notices .....</b>	<b>102</b>
<b>Appendix H — Specifications .....</b>	<b>104</b>



## List of Illustrations

Figure 1 — Typical DVR installation. ....	2
Figure 2 — 16-Channel DVR rear panel. ....	3
Figure 3 — Video input connectors. ....	4
Figure 4 — Video Loop-Through connectors. ....	4
Figure 5 — Video Out connectors. ....	4
Figure 6 — VGA connector. ....	5
Figure 7 — Audio In and Out connectors. ....	5
Figure 8 — Alarm Input connectors. ....	5
Figure 9 — Alarm Output connectors. ....	6
Figure 10 — Alarm Reset Input connectors. ....	6
Figure 11 — RS485 connector. ....	7
Figure 12 — Front USB connectors. ....	7
Figure 13 — Rear USB connector. ....	7
Figure 14 — RS232 connector. ....	8
Figure 15 — SCSI connector. ....	8
Figure 16 — Network connector. ....	9
Figure 17 — Factory reset switch. ....	9
Figure 18 — Power cord connector. ....	10
Figure 19 — 16-Channel DVR front panel. ....	11
Figure 20 — Infrared remote control. ....	12
Figure 21 — Login screen. ....	16
Figure 22 — Setup screen. ....	17
Figure 23 — Virtual Keyboard. ....	17
Figure 24 — Information screen. ....	18
Figure 25 — Upgrade screen. ....	19
Figure 26 — Setup Import screen. ....	19
Figure 27 — Setup Export screen. ....	20
Figure 28 — System Log screen. ....	20
Figure 29 — Date/Time setup screen. ....	21
Figure 30 — Holiday setup screen. ....	22
Figure 31 — Time Sync. screen. ....	22
Figure 32 — Storage Information screen. ....	23
Figure 33 — Device Format screen. ....	24
Figure 34 — Device Information screen. ....	24
Figure 35 — Storage Status screen. ....	25
Figure 36 — User setup screen. ....	26
Figure 37 — New Group setup screen. ....	27
Figure 38 — New User setup screen. ....	28
Figure 39 — Shutdown screen. ....	29
Figure 40 — Logout screen. ....	29
Figure 41 — Network menu. ....	30
Figure 42 — Network setup screen. ....	30
Figure 43 — LAN (Manual) setup screen. ....	31
Figure 44 — Port Numbers setup screen. ....	32
Figure 45 — LAN (DHCP) setup screen. ....	32
Figure 46 — LAN (ADSL) setup screen. ....	33
Figure 47 — Modem setup screen. ....	34
Figure 48 — DVRNS setup screen. ....	35

Figure 49 — Notification Mail setup screen. ....	37
Figure 50 — Authentication setup screen. ....	37
Figure 51 — Notification Callback setup screen. ....	38
Figure 52 — Device menu. ....	39
Figure 53 — Camera setup screen. ....	39
Figure 54 — Camera PTZ setup screen. ....	40
Figure 55 — PTZ Device list. ....	40
Figure 56 — Port Setup window. ....	41
Figure 57 — Audio setup screen. ....	41
Figure 58 — Alarm-Out Settings screen. ....	42
Figure 59 — Alarm-Out Schedule screen. ....	43
Figure 60 — Display OSD screen. ....	44
Figure 61 — OSD Margin screen. ....	45
Figure 62 — Main Monitor screen. ....	45
Figure 63 — Spot Monitor screen. ....	46
Figure 64 — Remote Control setup screen. ....	47
Figure 65 — Record menu. ....	48
Figure 66 — Record setup screen. ....	48
Figure 67 — Schedule setup screen. ....	49
Figure 68 — Default setup screen. ....	51
Figure 69 — Pre-Event setup screen. ....	51
Figure 70 — Archive setup screen. ....	52
Figure 71 — Event menu. ....	53
Figure 72 — Alarm-In Settings screen. ....	54
Figure 73 — Alarm-In Actions screen. ....	54
Figure 74 — Alarm-In Notify menu. ....	55
Figure 75 — Motion Detection Settings screen. ....	56
Figure 76 — Motion Detection Zone screen. ....	57
Figure 77 — Motion Detection Zone menu. ....	57
Figure 78 — Motion Detection Actions screen. ....	58
Figure 79 — Video Loss Settings screen. ....	59
Figure 80 — Video Loss Actions screen. ....	60
Figure 81 — Text-In Settings screen. ....	61
Figure 82 — Text-In Device Settings screen. ....	62
Figure 83 — Text-In Actions screen. ....	63
Figure 84 — System Event Settings screen. ....	65
Figure 85 — S.M.A.R.T. Setup screen. ....	65
Figure 86 — System Event Actions screen. ....	66
Figure 87 — Event Status screen. ....	67
Figure 88 — PTZ Select Camera menu. ....	71
Figure 89 — PTZ Preset screen. ....	72
Figure 90 — Preset view screen. ....	72
Figure 91 — PTZ menu. ....	73
Figure 92 — PTZ controls. ....	73
Figure 93 — Spot Monitor menu. ....	75
Figure 94 — Sequence menu. ....	75
Figure 95 — Mouse menu. ....	76
Figure 96 — Mouse Display menu. ....	77
Figure 97 — Mouse Playback controls. ....	80
Figure 98 — Search menu. ....	81
Figure 99 — Go to the Date/Time screen. ....	82

---

Figure 100 — Calendar Search screen. ....	82
Figure 101 — Event Log Search screen. ....	83
Figure 102 — Event Log Search Option screen. ....	84
Figure 103 — Text-In Search screen. ....	86
Figure 104 — Text-In Search Option screen. ....	87
Figure 105 — Motion Search screen. ....	88
Figure 106 — Motion Search Option screen. ....	88
Figure 107 — Clip-Copy screen. ....	90
Figure 108 — Print screen. ....	92
Figure 109 — ClipPlayer screen. ....	95



# Chapter 1 — Introduction

## Features

Your color digital video recorder (DVR) provides recording capabilities for nine or 16 camera inputs. It provides exceptional picture quality in both live and playback modes, and offers the following features:

- 9 or 16 Composite Video Input Connectors
- Compatible with Color (NTSC or PAL) and B&W (CCIR and EIA-170) Video Sources
- Auto Detection for NTSC and PAL
- Multiple Monitor Connectors: 1 BNC Video Out, 1 SVHS, 4 Spot, 1 VGA
- Multiple Search Engines (Date/Time, Calendar, Event)
- Records up to 120/100 Images per Second (NTSC/PAL) (PRO model: 240/200 ips)
- “Loop-Through” Video Connectors
- Continuous Recording in Disk Overwrite Mode
- Video Archiving via Ultra SCSI Interface
- 3 USB 2.0 Ports
- Continues Recording while Archiving, Transmitting to Remote Site and during Playback
- User-friendly Graphical User Interface (GUI) Menu System
- Multiple Recording Modes (Time-lapse, Pre-event, Alarm, Motion and Panic)
- 4-Channel Audio Recording and 1-Channel Audio Playback
- Text Input for ATM and POS
- Alarm Connections Include: Input, Output and Reset Input
- Built-in Alarm Buzzer
- Live or Recorded Video Access via Ethernet or Modem
- Time Synchronization using industry standard protocol
- Built-in CD-RW Drive
- Self-diagnostics with automatic notification including hard disk drive S.M.A.R.T. protocol
- Infrared Remote Control

## Technical Overview

In addition to replacing both a time-lapse VCR and a multiplexer in a security installation, your DVR has many features that make it much more powerful and easier to use than even the most advanced VCR.

The DVR converts analog NTSC or PAL video to digital images and records them on a hard disk drive. Using a hard disk drive allows you to access recorded video almost instantaneously; there is no need to rewind tape. The technology also allows you to view recorded video while the DVR continues recording video.

Digitally recorded video has several advantages over analog video recorded on tape. There is no need to adjust tracking. You can freeze frames, fast forward, fast reverse, slow forward and slow reverse without image streaking or tearing. Digital video can be indexed by time or events, and you can instantly view video after selecting the time or event.

Your DVR can be set up for event or time-lapse recording. You can define times to record, and the schedule can change for different days of the week and user defined holidays.

The DVR can be set up to alert you when the hard disk drive is full, or it can be set to record over the oldest video once the disk is full.

Your DVR uses a proprietary encryption scheme making it nearly impossible to alter video.

You can view video and control your DVR remotely by connecting via modem or Ethernet. There is a SCSI port that can be used to record or archive video to external hard disk drives, and there are also three USB ports that can be used to upgrade the system or copy video clips to external hard disk, CD-RW and flash drives.

**NOTE: This manual covers the 9- and 16-channel digital video recorders. The DVRs are identical except for the number of cameras and alarms that can be connected and the number of cameras that can be displayed. For simplicity, the illustrations and descriptions in this manual refer to the 16-camera model.**

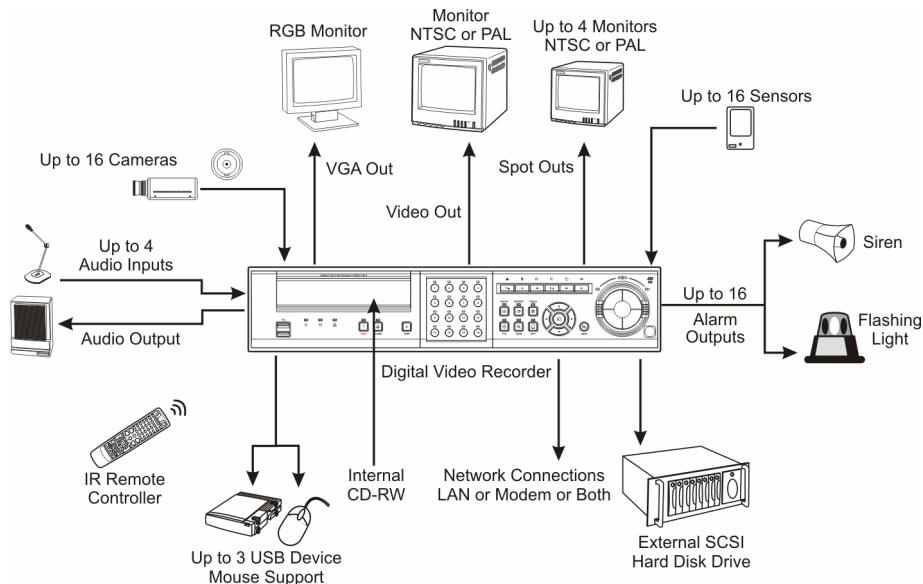

Figure 1 — Typical DVR installation.

## Chapter 2 — Installation

### Package Contents

The package contains the following:

- Digital Video Recorder
- Power Cord
- User's Manual (This Document)
- RAS Software CD and User's Manual
- Rack-mount Kit
- Assembly Screws Guide Rails for Adding Hard Disk Drives
- Infrared Remote Control

### Required Installation Tools

No special tools are required to install the DVR. Refer to the installation manuals for the other items that make up part of your system.

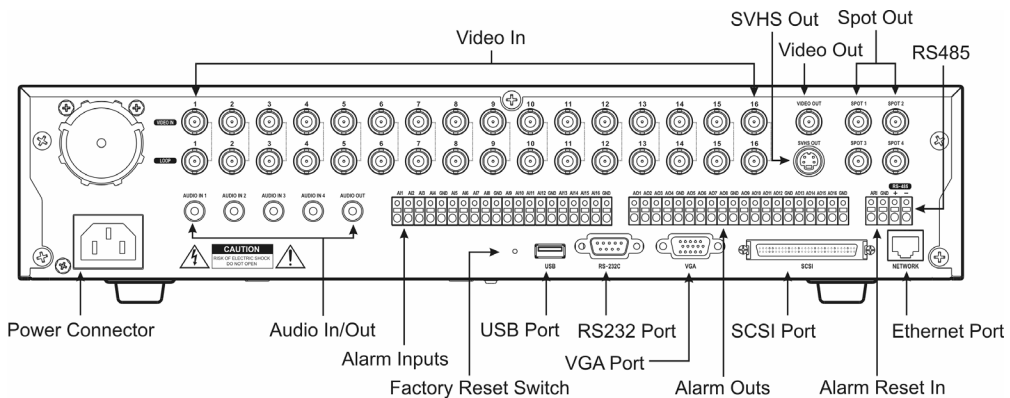

Figure 2 — 16-Channel DVR rear panel.

Your DVR can be used with either NTSC or PAL equipment.

**NOTE:** You cannot mix NTSC and PAL equipment. For example you cannot use a PAL camera and an NTSC monitor.

## Connecting the Video Input

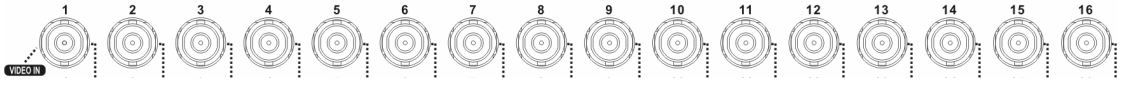

Figure 3 — Video input connectors.

Connect the coaxial cables from the video sources to the BNC Video In connectors.

## Connecting the Loop-Through Video

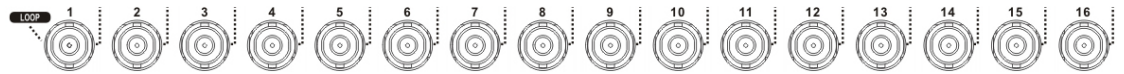

Figure 4 — Video Loop-Through connectors.

If you would like to connect your video source to another device, you can use the Loop BNC connectors.

**NOTE: The Loop BNC connectors are auto terminated. Do NOT connect a cable to the Loop BNC unless it is connected to a terminated device because it will cause poor quality video.**

## Connecting the Monitor

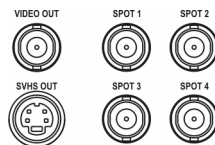

Figure 5 — Video Out connectors.

Connect the main monitor to either the Video Out or SVHS Out connector.

**NOTE: If your main monitor has an SVHS input, use it because it will give you better quality video display.**

**NOTE: The Video Out (BNC) and SVHS Out connectors may be connected to individual monitors for simultaneous operation.**

Up to four Spot monitors can be connected to the DVR. Connect the spot monitors to the SPOT 1, SPOT 2, SPOT 3 and SPOT 4 connectors as needed.

**NOTE: When the DVR is in the Search mode, it can display live video on the SPOT 1 monitor as shown on the main monitor during the live mode (PRO Model only).**



## Connecting a Computer VGA Monitor

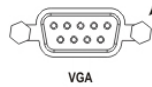

Figure 6 — VGA connector

A VGA connector is provided so that you can use a standard, multi-sync computer monitor as your main monitor. Use the cable supplied with your monitor to connect it to the DVR.

**NOTE:** Pressing and holding the **DISPLAY** button on the front panel for 5 seconds or longer will switch the video output between *Video Out (BNC or SVHS Out)* and *VGA Out*. During clip copy, you cannot switch the video output between *Video Out* and *VGA Out*.

**CAUTION:** The DVR will NOT record video for about 3 seconds while switching the video output between *Video Out* and *VGA Out*.

## Connecting Audio

**NOTE:** It is the user's responsibility to determine if local laws and regulations permit recording audio.



Figure 7 — Audio In and Out connectors.

Your DVR can record audio from up to four sources. Connect the audio sources to Audio In 1, Audio In 2, Audio In 3 and Audio In 4 as needed using RCA jacks. Connect Audio Out to your amplifier.

**NOTE:** The DVR does not have amplified audio output, so you will need a speaker with an amplifier. The DVR does not have a pre-amplifier for audio input, so the audio input should be from an amplified source, not directly from a microphone.

## Connecting Alarms

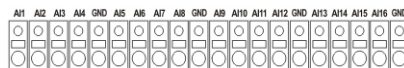

Figure 8 — Alarm Input connectors.

**NOTE:** To make connections on the Alarm Connector Strip, press and hold the button and insert the wire in the hole below the button. After releasing the button, tug gently on the wire to make certain it is connected. To disconnect a wire, press and hold the button above the wire and pull out the wire.

### AI 1 to 16 (Alarm-In)

You can use external devices to signal the DVR to react to events. Mechanical or electrical switches can be wired to the AI (Alarm-In) and GND (Ground) connectors. The threshold voltage is 4.3V and should be stable at least 0.5 seconds to be detected. See *Chapter 3 — Configuration* for configuring alarm input.

### GND (Ground)

**NOTE:** All the connectors marked GND are common.

Connect the ground side of the Alarm input and/or alarm output to the GND connector.

### AO 1 to 16 (Alarm-Out)



Figure 9 — Alarm Output connectors.

The DVR can activate external devices such as buzzers or lights. Connect the device to the AO (Alarm-Out) and GND (Ground) connectors. AO is an active low open collector output which sinks 5mA@12V and 30 mA@5V. See *Chapter 3 — Configuration* for configuring alarm output.

### ARI (Alarm Reset In)



Figure 10 — Alarm Reset Input connectors.

An external signal to the Alarm Reset In can be used to reset both the Alarm Out signal and the DVR's internal buzzer. Mechanical or electrical switches can be wired to the ARI (Alarm Reset In) and GND (Ground) connectors. The threshold voltage is below 0.3V and should be stable at least 0.5 seconds to be detected. Connect the wires to the ARI (Alarm Reset In) and GND (Ground) connectors.

## Connecting RS485



Figure 11 — RS485 connector.

The DVR can be controlled remotely by an external device or control system, such as a control keyboard, using RS485 half-duplex serial communications signals. The RS485 connector can also be used to control PTZ (pan, tilt, zoom) cameras. Connect RX-/TX- and RX+/ TX+ of the control system to the - and + (respectively) of the DVR. See *Chapter 3 — Configuration* and the PTZ camera or remote controller manufacture’s manual for configuring the RS485 connection.

## Connecting to the USB Ports

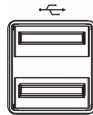

Figure 12 — Front USB connectors.



Figure 13 — Rear USB connector.

Three USB ports are provided to connect external hard disk, CD-RW or flash drives for video clip copying or system upgrades. One USB port is on the rear panel and the other two are on the front panel. Position external drives close enough to the DVR so that you can make the cable connections, usually less than 6 feet. Use the USB cable provided with the hard disk drive to connect it to the DVR.

A USB mouse (not supplied) can be connected to one of the ports. You can use the mouse to navigate through the screens and menus much like you would on a computer.

A PostScript™ USB printer (not supplied) can be connected to one of the ports. You can print selected images resulting from a search. *Refer to Chapter 4 — Operation, Searching Video.*

A USB to Serial converter can be connected to the USB port. Multiple text-in devices can be used with a USB to Serial converter.

## Connecting to the RS232 Port

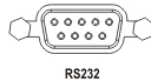

Figure 14 — RS232 connector.

An RS232 port is provided to connect an external modem for remote monitoring, configuration and software upgrades, and to connect a remote control keyboard. Use a modem cable with a DB-9S (female) connector to connect to the DVR. See *Chapter 3 — Configuration* for configuring the modem.

**NOTE:** The DVR is not supplied with a modem cable, and many modems are not supplied with cables. Make certain you have the correct cable when purchasing the modem.

## Connecting to the Ultra Wide SCSI Port

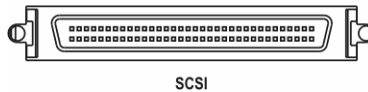

Figure 15 — SCSI connector.

A SCSI port is provided to connect external storage devices for recording or archiving video. Connect the external SCSI hard disk drive (RAID) cable to the high-density 68-pin female UltraWide SCSI port. The length of SCSI cable should not exceed 5 feet (1.5 meters). You can connect up to 8 UltraWide SCSI devices with SCSI IDs set from 0 to 15 except for 7, which is assigned as the Host ID.

**NOTE:** The SCSI bus must be terminated, otherwise the DVR will not operate properly.

**CAUTION:** Do NOT connect or disconnect the SCSI device while the DVR power is on. The DVR must be powered down to connect or disconnect the SCSI device. Power up the SCSI device so it is ready for operation before powering up the DVR. Power down the SCSI device after powering down the DVR and then disconnect the SCSI device.

**CAUTION:** If the SCSI device is shut down while the device is operating, the DVR system might not operate normally.

## Connecting to the Network Port

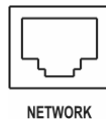

Figure 16 — Network connector.

The DVR can be networked using the 10/100Mb Ethernet connector. Connect a Cat5 cable with an RJ-45 jack to the DVR connector. The DVR can be networked with a computer for remote monitoring, searching, configuration and software upgrades. See *Chapter 3 — Configuration* for configuring the Ethernet connections.

## Factory Reset

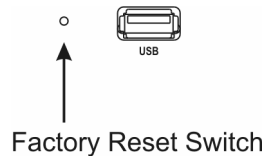

Figure 17 — Factory reset switch.

The DVR has a Factory Reset switch to the left of the USB port on the rear panel. This switch will only be used on the rare occasions that you want to return all the settings to the original factory settings.

**CAUTION: When using the *Factory Reset*, you will lose any settings you have saved. If you want to use the same DVR name registered on the DVRNS server after initializing the system using the factory reset, you need to contact the DVRNS server manager. Please record and save the help desk information before factory reset.**

To reset the unit, you will need a straightened paperclip:

1. Turn the DVR off.
2. Turn it on again.
3. While the DVR is initializing, the front panel LEDs will blink. When any of the Camera 1 to 8 LEDs blink, poke the straightened paperclip in the unlabeled hole to the left of the USB port.
4. Hold the switch until all the LEDs on the front panel are lit.

**NOTE: When the DVR successfully resets to factory defaults all the LEDs on the front panel flash five times.**

5. Release the reset switch. All of the DVR's settings are now at the original settings it had when it left the factory.

## Connecting the Power Cord

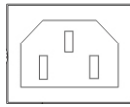

Figure 18 — Power cord connector.

Connect the AC power cord to the DVR and then to the wall outlet.

**WARNING: ROUTE POWER CORDS SO THAT THEY ARE NOT A TRIPPING HAZARD. MAKE CERTAIN THE POWER CORD WILL NOT BE PINCHED OR ABRADED BY FURNITURE. DO NOT INSTALL POWER CORDS UNDER RUGS OR CARPET.**

**THE POWER CORD HAS A GROUNDING PIN. IF YOUR POWER OUTLET DOES NOT HAVE A GROUNDING PIN RECEPTACLE, DO NOT MODIFY THE PLUG. DO NOT OVERLOAD THE CIRCUIT BY PLUGGING TOO MANY DEVICES IN TO ONE CIRCUIT.**

Your DVR is now ready to operate. Refer to *Chapter 3 — Configuration* and *Chapter 4 — Operation*.

## Chapter 3 — Configuration

**NOTE:** Your DVR should be completely installed before proceeding. Refer to *Chapter 2 — Installation*.

### Front Panel Controls

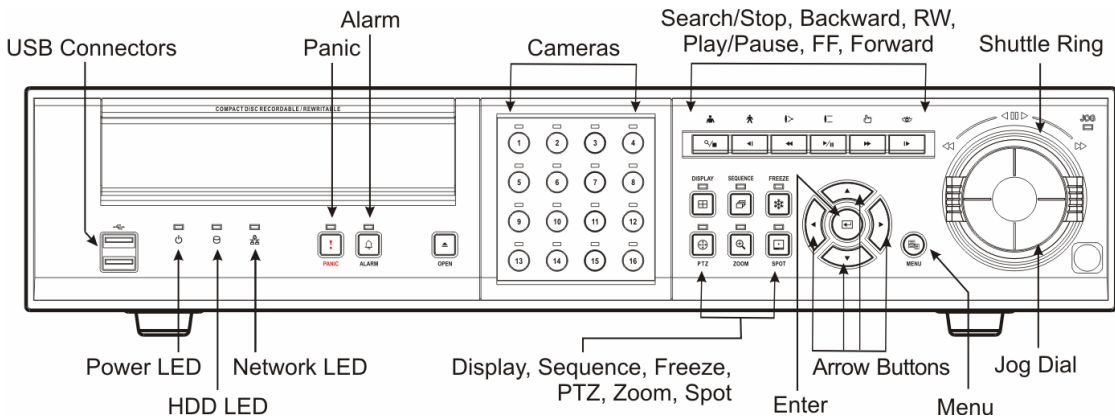

Figure 19 — 16-Channel DVR front panel.

The front panel looks and operates much like a VCR combined with a multiplexer. Many of the buttons have multiple functions. The buttons on the infrared remote control, while laid out differently, perform the same functions as those on the front panel. The following describes each button and control. Take a few minutes to review the descriptions. You will use these to initially set up your DVR and for daily operations.

**NOTE:** The sensor for the infrared remote control is just to the lower left of the jog-shuttle. Make certain that nothing blocks the sensor, or the remote control will not function properly.

**NOTE:** You can also use a USB mouse (not supplied) to navigate through the screens and menus much like you would on a computer.

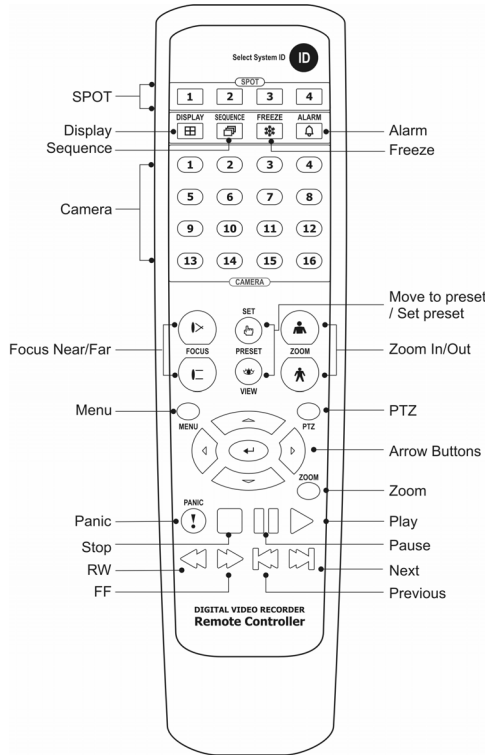

Figure 20 — Infrared remote control.

### POWER LED

The POWER LED is lit when the unit is On.

### HDD LED

The HDD LED flickers when the DVR is recording or searching video on the hard disk drive.

### NETWORK LED

The NETWORK LED flickers when the unit is connected to a network via either Ethernet or modem.

### Camera Buttons (1 to 16)

Pressing the individual camera buttons will cause the selected camera to display full screen. Buttons 1 to 9 are also used to enter passwords.



## PANIC Button

Pressing the **PANIC** button starts panic recoding of all camera channels, and displays  on the screen. Pressing the button again will stop panic recording.

## ALARM Button

The **ALARM** button has two functions. First, it will reset the DVR's outputs including the internal buzzer during an alarm. Second, it will display the event log when you are in the live monitoring mode unless there is an active alarm. This operation can be user password protected.







## SEARCH/STOP Button

Pressing the **SEARCH/STOP** button enters the Search menu. Pressing the button again exits the Search mode. You will need to log into the system with a qualified user to enter the Search mode from the Live Monitoring mode. The **SEARCH/STOP** button on the front panel Zooms In while in the PTZ mode.



## BACKWARD Button

Pressing the **BACKWARD** button goes to the previous image. The button on the front panel is also used to Zoom Out while in the PTZ mode.







## RW (Rewind) Button

Pressing the **RW** button plays video backward at high speed. Pressing the button again toggles the playback speed from ,  and . The screen displays ,  and  respectively. The button on the front panel is also used for Near Focus in the PTZ mode.

## PLAY/PAUSE Button

Pressing the **PLAY/PAUSE** button plays back images at regular speed. Pressing the button while in the Playback mode pauses the video. The screen displays  when the DVR is playing back video. The screen displays  when in the Pause mode. The button is also used for Far Focus while in the PTZ mode.

## FF (Fast Forward) Button

Pressing the **FF** button plays video forward at high speed. Pressing the button again toggles the playback speed from ,  and . The screen displays ,  and  respectively. The button on the front panel is also used to save Presets while in the PTZ mode.

## FORWARD Button

Pressing the **FORWARD** button goes to the next image. The button on the front panel is also used to load a Preset View in the PTZ mode.

## DISPLAY Button

The **DISPLAY** button has two functions. First, it toggles between different display formats. The available formats are: full, 4x4, 3x3, 2x2 and PIP. Second, pressing and holding the button for 3 seconds or longer will switch the video output between Video Out (BNC or SVHS Out) and VGA Out.

## SEQUENCE Button

When in the live mode, pressing the **SEQUENCE** button displays live channels sequentially.

## FREEZE Button

Pressing the **FREEZE** button freezes the current live screen.

## PTZ Button

Pressing the **PTZ** button enters the PTZ (Pan/Tilt/Zoom) mode which allows you to control properly configured cameras.

## ZOOM Button

Pressing the **ZOOM** button zooms the current image on the screen. A PIP with a rectangle temporarily displays showing what area of the screen has been enlarged. You can use the arrow buttons to move the rectangle to another area. Pressing the **↵** (Enter) button toggles the zoom size between 2x, 3x and 4x.

## SPOT Button

Pressing the **SPOT** button allows you to select which cameras will display on the four Spot Monitors. After selecting the monitor you can opt to have that Spot Monitor displays a single camera or all cameras sequentially. The infrared remote control allows you to go directly to the individual Spot Monitor menus.

## Enter Button

The **↵** (Enter) button selects a highlighted item or completes an entry that you have made during system setup.

## Up, Down, Left, Right Arrow Buttons

These buttons are used to navigate through menus and GUI. You can also use them to change numbers by highlighting a number in the menu and using the Up and Down arrow buttons to increase or decrease the number's value.

The arrow buttons are also used to control Pan and Tilt when in the PTZ mode. When in the PIP display format, pressing the Up and Down arrow buttons moves the position of the small screen counter-clockwise and clockwise, and pressing the Left and Right buttons moves through screen pages.

## MENU Button

Pressing the **MENU** button enters the Setup screen. You will need to enter the authorized user and password to access Setup. Pressing the button also closes the current menu or setup dialog box. In the Playback mode, pressing the **MENU** button displays the Search menu. In Search mode clip-copying can be done instantly by pressing and holding the button for two or more seconds.

## Shuttle Ring

The Shuttle Ring only functions in the Playback mode. The Shuttle Ring is spring loaded and returns to the center position when released. Turning the ring clockwise plays video forward. Turning the ring counterclockwise plays video backward. Playback speed varies with the amount the ring is turned. The playback speeds are ◀, ◀◀, ◀◀◀, ◀◀◀◀, ▶, ▶▶, ▶▶▶ and ▶▶▶▶.

When you release the ring, it snaps back to the center position and the video pauses.

## Jog Dial

When in the playback mode, you can play video forward image-by-image by turning the Jog Dial clockwise and backward image-by-image by turning the Jog Dial counterclockwise.

When in the PIP mode, you can make the PIP screen smaller by turning the Jog Dial clockwise and larger by turning the Jog Dial counterclockwise.

When in the Setup mode, you can change number values by highlighting the item in the menu and turning Jog Dial clockwise or counterclockwise to increase or decrease the number.

## ID Button on Remote Control



If a DVR System ID is set to 0, the infrared remote control will control that DVR without any additional operations. (Refer to the *System Information* setup screen in this chapter for further information on setting the System ID.) If the system ID is 1 to 16, you must to press the **ID** button on the remote control and then press the number button (1 to 16) in order to control that DVR. If the System ID of two or more DVRs is set to 0, those DVRs will all react to the infrared remote control at the same time.

## Turning on the Power

Connecting the power cord to the DVR turns on the unit. The unit takes approximately 60 seconds to initialize.

## Initial Unit Setup

Before using your DVR for the first time, you will want to establish the initial settings. This includes items such as time and date, display language, camera, audio, remote control, record mode, network and password. Your DVR can be set up using various screens and dialog boxes.

Throughout the screens you will see . Highlighting the  and pressing the  button gives you the opportunity to reset that screen to its default settings.

Press the **MENU** button to enter the setup screens. The Login screen appears.

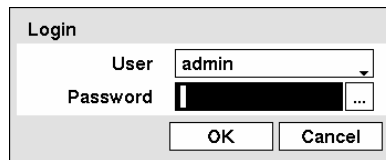



Figure 21 — Login screen.

Select a User and enter the password by pressing the appropriate combination of Camera number buttons and then the  button. There is no default password when logging in the admin user for the first time.

**NOTE:** To assure the secure management of the system, the password setup is strongly recommended.

**NOTE:** In case of not using the front panel buttons or the infrared remote control, you can access the *Login* screen using the mouse (not supplied). Click the right mouse button to display the *Login* screen. To enter the password, press the  button to display the virtual keyboard. See below for using the virtual keyboard.

## Setup Screen



Figure 22 — Setup screen.

Press the **MENU** button to enter the setup screen.

While setting up the DVR, there will be many opportunities to enter names and titles. When making these entries, a Virtual Keyboard will appear.



Figure 23 — Virtual Keyboard.

Use the arrow keys to highlight the character you want in the name or title and press the **↩** button. That character appears in the title bar and the cursor moves to the next position. Pressing **↵** toggles between the upper and lower case keyboards, **←** backspaces, and **✕** deletes entered characters. You can use up to 31 characters including spaces in your title.

Special characters can be created using **^** and a capital letter; e.g., **^J** for NL (New Line), **^M** for CR (Carriage Return). Special characters are commonly used by text input devices and will be useful when performing Text-In Searches.

## System Information

Highlight Information and press the  button. The Information screen appears.

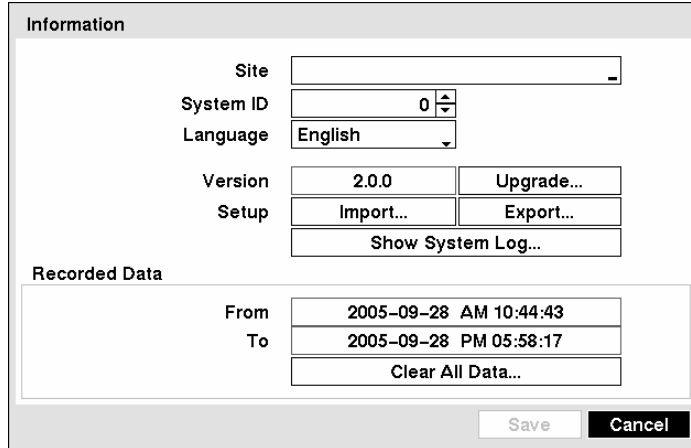



The screenshot shows the 'Information' screen with the following elements:

- Site:** A text input field.
- System ID:** A numeric input field with the value '0' and up/down arrow buttons.
- Language:** A drop-down menu showing 'English'.
- Version:** A text box with '2.0.0' and an 'Upgrade...' button.
- Setup:** 'Import...' and 'Export...' buttons.
- Show System Log...:** A button.
- Recorded Data:**
  - From:** '2005-09-28 AM 10:44:43'
  - To:** '2005-09-28 PM 05:58:17'
  - Clear All Data...:** A button.
- Buttons:** 'Save' and 'Cancel' buttons at the bottom right.

Figure 24 — Information screen.



In the **Information** screen, you can name the site location, assign a System ID number, select the language the screens are displayed in, display software version number, upgrade the software, show the System Log, show Event Status, display recorded time data, and clear all data.

Highlight the **Site** box and press the  button. A virtual keyboard appears that you can use to enter a Site Name.

Once you have entered your title, highlight **Close** and press the  button.

Highlight the box beside **System ID** and press the  button. Change the number by highlighting it and using the **Up** and **Down** arrow buttons to increase and decrease the number from 0 to 99.

**NOTE: The System ID number is used to identify the unit when it is connected with other DVRs through the RS-485 port. You cannot use the same ID number for two or more DVRs that are in the same RS-485 network. It is possible to have multiple DVRs with System ID 0 that are in the same area as long as they are not part of an RS-485 network. If this is the case, all will be controlled at the same time when using the infrared remote control.**

Highlight the box beside **Language** and press  button. A drop-down menu displays the available languages. Highlight the desired language and press the  button.

The box beside **Version** displays the software version of the DVR.

To upgrade the software, connect a USB device containing the upgrade package file to the DVR. Highlight **Upgrade...** and press the **↵** button. The **Upgrade** screen appears. The screen displays the upgrade package file names that are available. The “.rui” indicates that the file is for software upgrades and “.off” indicates that the file is for optical drive’s firmware upgrades. Select the desired file and press the **↵** button. Highlighting the **Install** button and pressing the **↵** button will install the selected software package. Highlighting the **Cancel** button and pressing the **↵** button will close the window without upgrading the software. If the upgrade package file is not installed on the DVR properly, you will get an error message. The system restarts automatically after completing the upgrade.



Figure 25 — Upgrade screen.

**NOTE:** The **Upgrade** button will be deactivated if the hard disk drive has not been formatted as it requires the space for temporary files when upgrading the system.

**CAUTION:** The USB device must be FAT16 or FAT32 format.

You can import saved DVR settings or export the current DVR settings. To import saved DVR settings, connect the USB device containing the setup file (.dat) to the DVR. Highlight **Setup – Import...** and press the **↵** button. Select the desired setup file and press the **Import** button to import the selected settings and change the DVR settings accordingly. Highlight **Include Network Setup** and press the **↵** button to toggle between On and Off. When set to Off, the network settings will not be changed.

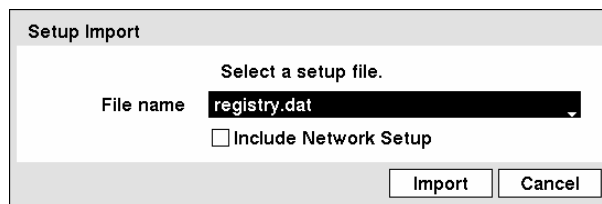

Figure 26 — Setup Import screen.

To export the current DVR settings, connect the USB device to the DVR. Highlight **Setup – Export...** and press the **↵** button. Highlight the box beside **File name** and press the **↵** button. A virtual keyboard allows you to enter the file name. Selecting **Export** will export the current settings in .dat file format on the USB device.



Figure 27 — Setup Export screen.

**NOTE:** Even after changing the DVR settings by importing saved settings, the time-related settings (Date/Time, Time Zone and Daylight Saving Time) will NOT be changed.

**CAUTION:** The USB device must be FAT16 or FAT32 format.

Highlight Show System Log... and press the  button to display the System Log.

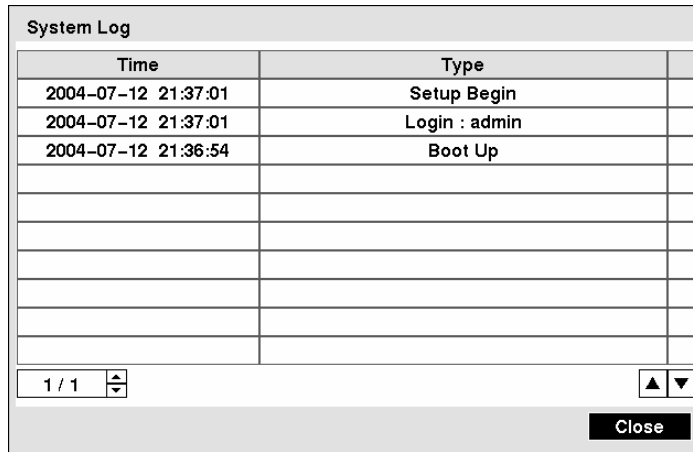



Figure 28 — System Log screen.

The System Log screen lists system activities (up to 5,000 from the latest) that have occurred along with the time and date. The icon  will be displayed in the last column for system activities of the remote site. You can scroll through the log pages by using the Up and Down arrows, or you can go directly to a log page by entering the log page number in the box at the bottom left of the screen. Highlight Close and press the  button to exit the screen.

The box beside Recorded Data – From / To displays the time information of recorded data.

Highlighting Clear All Data... and pressing the  button will clear all video data. You will be asked to verify that you wish to clear all data before the DVR erases the video data. Clear All Data... will not clear the System Log.

After you are finished with the Information Screen, you can highlight Save and press the  button to save the changes and exit the screen. If you do not wish to save the changes, highlight Cancel and press the  button to exit the screen.





## Date/Time Setup

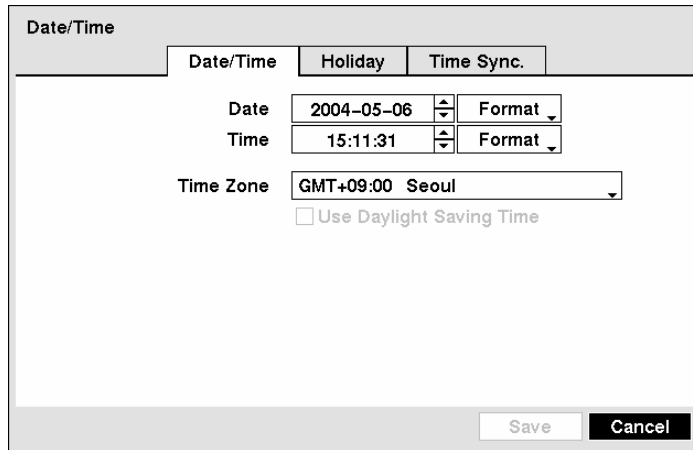

Highlight **Date/Time** in the System menu and press the  button. The Date/Time setup screen appears.







Date/Time		
Date/Time	Holiday	Time Sync.
Date	2004-05-06	Format
Time	15:11:31	Format
Time Zone	GMT+09:00 Seoul	
	<input type="checkbox"/> Use Daylight Saving Time	
		Save Cancel

Figure 29 — Date/Time setup screen.



Highlight the first box beside **Date** and press the  button. The individual sections of the date will highlight. Use the **Up** and **Down** arrow buttons to change the number. Use the **Left** and **Right** arrow buttons to move between month, date and year. Once you have the correct date, press the  button.



Highlight the **Format** box beside **Date** and press the  button. Select from the three available date formats and press the  button to save your selected format.

Highlight the first box beside **Time** and press the  button. The individual sections of the time will highlight. Use the **Up** and **Down** arrow buttons to change the number. Use the **Left** and **Right** arrow buttons to move between hour, minutes and seconds. Once you have the correct time, press the  button.

Highlight the **Format** box beside **Time** and press the  button. Select from the three available time formats and press the  button to save your selected format.

**NOTE: The clock will not start running until you have highlighted **Save** and pressed the  button.**

Highlight the box beside **Time Zone** and press the  button. Select your time zone from the list and press the  button.

Highlight **Use Daylight Saving Time** and press the  button. Pressing the  button toggles between **On** and **Off**.

Highlight the Holiday tab, and the Holiday setup screen appears

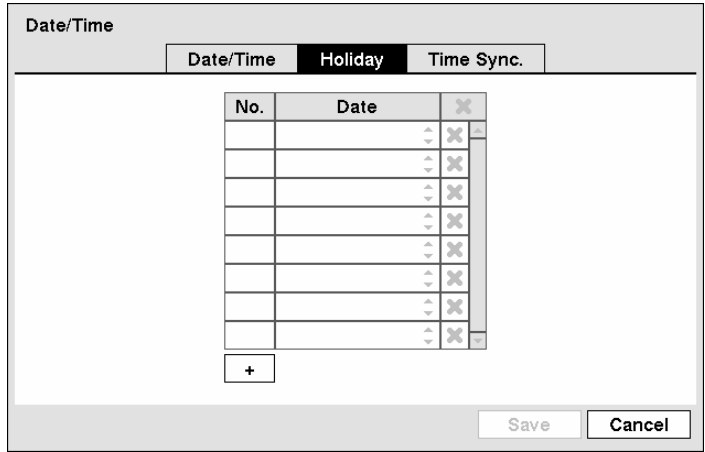

Figure 30 — Holiday setup screen.

You can set up holidays by highlighting + and pressing the button. The current date appears.

Highlight the month and day and change them by using the Up and Down arrow buttons. Press the button to add the date. Dates can be deleted by highlighting the X beside the date and pressing the button.

**NOTE: Holidays that do not fall on the same date each year should be updated once the current year's holiday has passed.**

Highlighting the Time Sync. tab causes the Time Sync. screen to display. You can set up time synchronization between the DVR and standard time servers that are available in most time zones and countries, or between the DVR and another DVR.

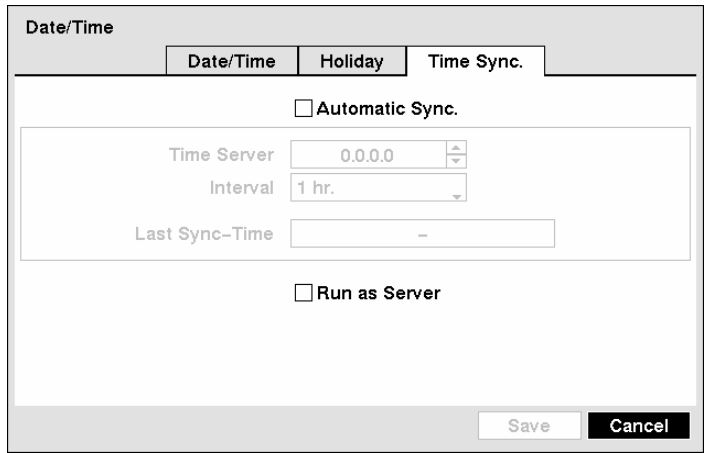

Figure 31 — Time Sync. screen.

Highlight the box beside **Automatic Sync.** and press the  button. This toggles between On and Off.

Highlight the box beside **Time Server** and press the  button. Change the numbers by highlighting them and using the Up and Down arrow buttons to increase or decrease the number value.

Highlight the box beside **Interval** and press the  button. Set the time interval for synchronization from 30 minutes to 1 day at various time intervals.

**Last Sync-Time** displays the last time the DVR was synchronized with the time server.

Highlight **Run as Server** and press the  button. Pressing the  button toggles between On and Off. When it is On, the DVR you are setting up will run as a time server.

You can save your changes by highlighting **Save** and pressing the  button. Selecting **Cancel** exits the screen without saving the changes.

## Storage Screen

Highlight **Storage** in the System menu and press the  button. The **Storage** setup screen appears and displays information about the DVR's storage devices.

Type	Capacity	Format	Information
Internal 1	37.29 GB	Record ...	In Use ...
Internal 2	37.29 GB	Record ...	In Use ...
USB 1	37.29 GB	Archive ...	In Use ...
		...	...
		...	...
		...	...
		...	...
		...	...

Figure 32 — Storage Information screen.

The information in the **Type** column describes the storage device.

The capacity of the storage device is displayed in the **Capacity** column.

The Format column displays whether the device is used for recording (Record) or archiving (Archive). Not Using indicates the device is not used for either recording or archiving. Unformatted indicates the device is not formatted.  indicates when the device has temporary space set aside so that video clips can be saved on a CD-RW or DVD RW.

Highlight the box in the Format column for the desired storage device and press the  button. You will be able to format the device to be prepared for recording or archiving. When selecting Not Using from the Use As and highlighting Format button, the device will not be used either recording or archiving. You can also set aside space to store temporary files for CD or DVD burning by selecting Partition – CD/DVD Burn.

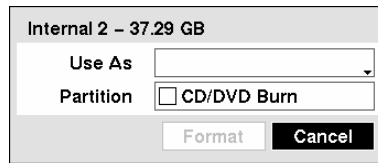



Figure 33 — Device Format screen.

**NOTE: A USB hard disk drive can be formatted and used only for archiving.**

**NOTE: The DVR does NOT support USB hard disk drives with a version lower than 2.0.**

**NOTE: System upgrade requires the formatted internal hard disk drive, so please do not uninstall internal hard disk drives even though they are not used for either recording or archiving (e.g. when using only the external SCSI hard disk drives). Set the Use As of the internal hard disk drive to *Not Using* and format it.**

The Information column displays whether the device is being used or not. Other indicates the device has been used for another DVR.

Highlight the box in the Information column for the desired storage device and press the  button. You will be able to check the time information of recorded data.

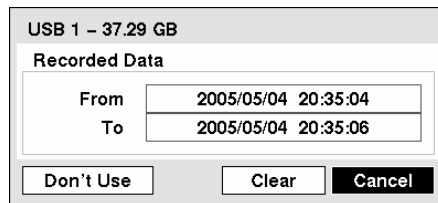



Figure 34 — Device Information screen.

If you want to erase recorded data on the selected device, highlight Clear and press the  button. You will be asked whether or not you want to delete the data.

If you want to use a USB hard disk drive, highlight **Use** and press the  button after connecting the device. Highlight **Don't Use** and press the  button if you want to stop using the device.

**NOTE:** When disconnecting a USB hard disk drive from the DVR, highlight *Don't Use* first and then disconnect the device.

**CAUTION:** Do NOT disconnect the USB cable or the power from the device while copying video clips. If the USB cable is disconnected while copying video clips, archived data might be lost.

Highlight the **Status** tab, and the Storage Status screen displays.

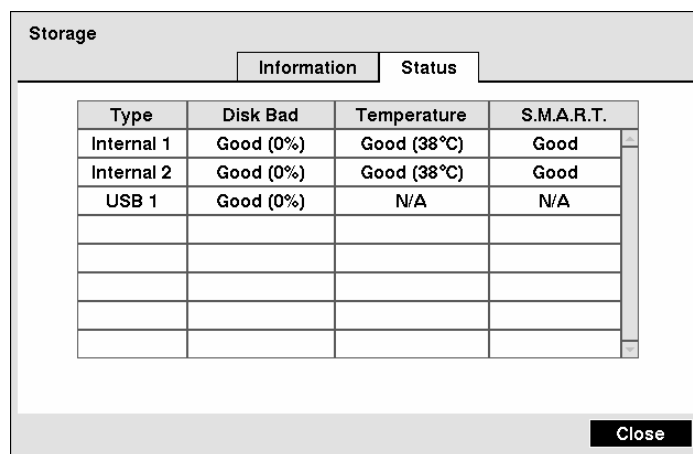

Storage			
Information		Status	
Type	Disk Bad	Temperature	S.M.A.R.T.
Internal 1	Good (0%)	Good (38°C)	Good
Internal 2	Good (0%)	Good (38°C)	Good
USB 1	Good (0%)	N/A	N/A

**Close**

Figure 35 — Storage Status screen.

The **Type** column displays the type of storage device.

The **Disk Bad** column displays the percentage of bad sectors. **Unformatted** indicates the device is not formatted.

The **Temperature** column displays the temperature of the storage device.

The **S.M.A.R.T.** column displays “Good”, “Bad” or “N/A”, depending on storage conditions.

- **Good** — The storage condition is normal.
- **Bad** — Data cannot be written on or read from the storage device.
- **N/A** — Storage conditions are normal, however, the S.M.A.R.T. monitoring is not working or supported

**NOTE:** When the storage condition is “Bad”, the **Event Status – Storage** screen displays and you can check the storage condition for details. Once the “Bad” message displays, replacing the hard disk drive is recommended, usually within 24 hours.

**NOTE:** *Temperature* and *S.M.A.R.T.* information will be available only for IDE hard disk drives supporting the SMART (Self-Monitoring Analysis and Reporting Technology) monitoring program.

Selecting Close and pressing the  button exits the screen.

## User Setup Screen

Highlight **User** in the System menu and press the  button. The **User** setup screen displays the authorized groups and users. You can add and delete groups and users. When adding a group, you can assign authority levels to the group.

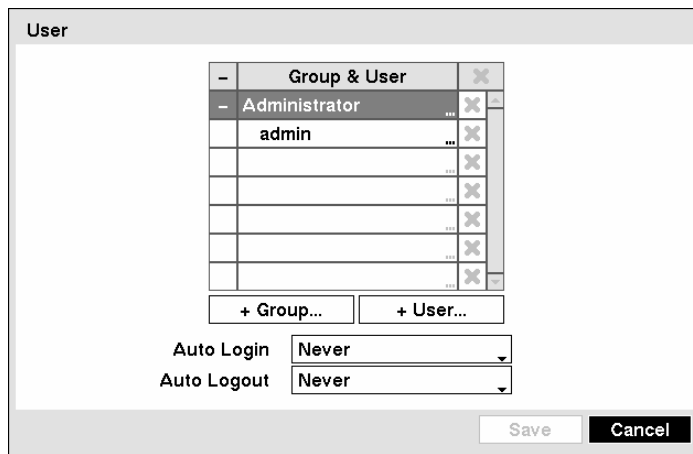





Figure 36 — User setup screen.

The +/- column is used to collapse and expand user groups. If there is a + or – in this column, it indicates the item is a Group Name. If there is a – in front of the Group Name, it indicates that the group has been “expanded” and all of the User Names within that group are displayed below the Group Name. If there is a + in front of the Group Name, it indicates that the group has been “collapsed” and all of the User Names within that group are hidden. To collapse or expand a group, highlight the +/- column in front of the desired group and press the  button.

Highlighting a Group Name and pressing the  button allows you to change the authority levels assigned to the group.

**CAUTION:** Write down the new password and save it in a secure place. If the password is forgotten, the unit must be reset using the *Factory Reset Button* and all data settings will be lost.

Highlighting a User Name and pressing the  button allows you to add or change the password assigned to that user. You can also change the group to which the user is assigned.

The ✕ column can be used to delete a User Name or an entire Group. If the ✕ is grayed out, that Group or User cannot be deleted. Highlight the ✕ and press the  button. You will be asked to confirm that you want to delete the User or Group.

To add a Group, highlight the + Group... box and press the  button. A virtual keyboard appears allowing you to enter the Group name. You can use up to 15 characters including spaces in the group name. Enter the name and assign authority levels to the group.

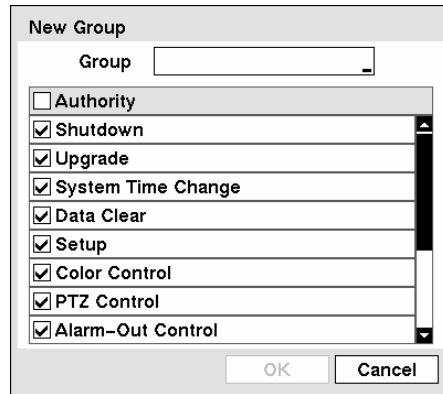





Figure 37 — New Group setup screen.

Highlighting the Authority box and pressing the  button will toggle between all authority levels being turned On and Off. Highlighting the individual authority level boxes and pressing the  button will toggle between that authority level being turned On and Off. The authority levels that can be turned On and Off are:

- **Shutdown** — The user can shut the system down on a local system.
- **Upgrade** — The user can upgrade the software on a local system or the PC running RAS.
- **System Time Change** — The user can change the system date and time on a local system or the PC running RAS.
- **Data Clear** — The user can clear all video data or format disks on a local system or the PC running RAS.
- **Setup** — The user without Setup authority cannot establish any system settings excluding system shutdown and logout on a local system or the PC running RAS.
- **Color Control** — The user can control brightness, contrast, hue and saturation for cameras on a local system or the PC running RAS.
- **PTZ Control** — The user can control the PTZ camera on a local system or the PC running RAS.
- **Alarm-Out Control** — The user can reset the DVR's outputs including the internal buzzer during an alarm by pressing the **ALARM** button on a local system or alarm-out control button on the PC running RAS.

- **Covert Camera View** — The user can view video from cameras set as Covert while in the Live Monitoring or Search mode on a local system or the PC running RAS.
- **System Check** — The user can view the remote system status or check the remote system status as a batch process on the PC running RAS.
- **Record Setup** — The user can establish all Record settings on a local system or the PC running RAS.
- **Search** — The user can access the Search mode on a local system or the PC running RAS.
- **Clip-Copy** — The user can copy video clips on a local system or the PC running RAS, and save video data in an AVI, bitmap or JPEG file format.

To add a User, highlight the + User... box and press the  button. A virtual keyboard appears allowing you to enter the User Name. Enter the name and assign the User to a Group and password. You can use camera buttons 1 to 9 on either the front panel or remote control to assign the password. The password can be up to 8 digits. You will be asked to confirm the password.

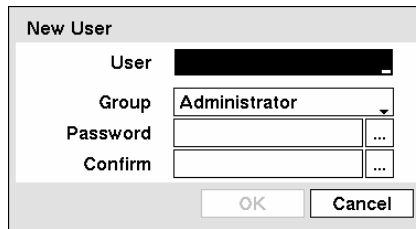



Figure 38 — New User setup screen.

**NOTE: In case of not using the front panel buttons or the infrared remote control, you can use the virtual keyboard to assign the password. To display the virtual keyboard press the  button using the mouse (not supplied).**

Highlighting the box beside **Auto Login** allows you to select a User to be automatically logged in when the DVR is powered up. It can also be set to never automatically login a user.

Highlighting the box beside **Auto Logout** allows you to select from a list of times that the user will be automatically logged out. The options are: Never, 1 min., 3 min., 5 min., 10 min., 15 min., 20 min., 25 min., 30 min. and 1 hr.

You can save your changes by highlighting **Save** and pressing the  button. Selecting **Cancel** exits the screen without saving the changes.



## Shutdown Screen

Highlight **Shutdown** in the System menu and press the **↵** button. The **Shutdown** screen displays asking you to confirm whether or not you want to shut the system down.

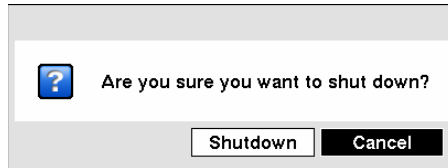

Figure 39 — Shutdown screen.

After selecting **Shutdown** and pressing the **↵** button, a screen will appear telling you when it is safe to disconnect power.

## Logout Screen

Highlight **Logout** in the System menu and press the **↵** button. The **Logout** screen displays asking you to confirm whether or not you want to log out the current user.

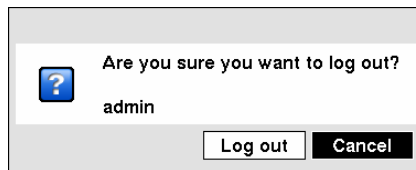

Figure 40 — Logout screen.

After selecting **Logout** and pressing the **↵** button, the user will be logged out.

## Network & Notification Setup

In the Main screen, use the Left or Right arrow buttons to display the Network menu.



Figure 41 — Network menu.

### Network Screen

Highlight **Network** in the Network menu and press the button. The **Network** setup screen displays. You will be able to change the Network, LAN, Modem and DVRNS settings.

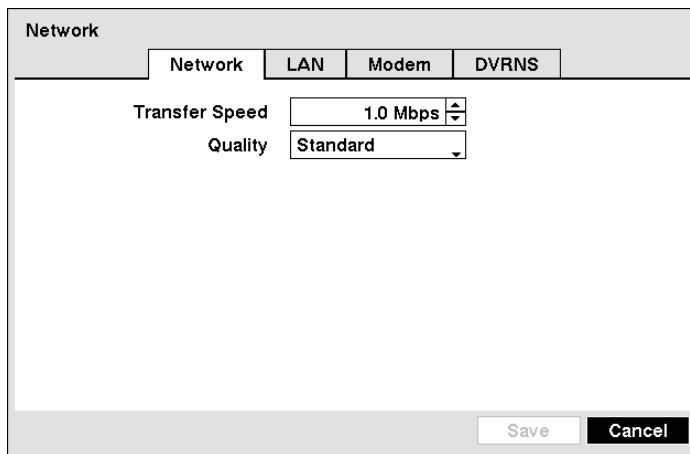

Figure 42 — Network setup screen.

Highlight the box beside **Transfer Speed**. Press the Up and Down arrow buttons to set the Transfer Speed from 50Kbps to 100Mbps. Press the button to set the transfer speed.

Highlight the box beside **Quality** and press the button. You can select the Quality from: Very High, High, Standard and Low. Press the button to set the Quality.

**NOTE: The higher Quality settings require higher Transfer Speed settings. The transfer speed you set is the maximum speed. Depending on the network environment, this speed may not be achieved.**

**NOTE: The local recording speed might be affected by various network bandwidth (Transfer Speed) conditions.**

## LAN Setup Screen

Highlight the LAN tab, and the LAN screen displays.

Figure 43 — LAN (Manual) setup screen.

Highlight the box beside **Type** and press the button. You can select the type of network configuration from: Manual, DHCP and ADSL (with PPPoE). Select the desired type and press the button.

Selecting **Manual** from the **Type** allows you to set up LAN parameters manually.

**NOTE: You will need to get the appropriate IP Address, Gateway and Subnet Mask from your network administrator.**

Change the numbers by highlighting them and using the **Up** and **Down** arrow buttons to increase or decrease the number.

The factory default LAN settings are:

IP Address: 192.168.1.129  
 Gateway: 192.168.1.254  
 Subnet Mask: 255.255.255.0

Highlight the box beside **DNS Server**. Press the **Up** and **Down** arrow buttons to set the IP address of the DNS server. If you set up the DNS Server, the domain name of the DVRNS server instead of the IP address can be used during the DVRNS Server setup. (Refer to the *DVRNS Setup* section for details.)

Highlight the **Port Number Setup...** box and press the button. The **Port Number Setup** screen appears.

**NOTE: You will need to get the appropriate Port Numbers for each RAS related program (Admin, Callback, Watch and Search) from your network administrator.**

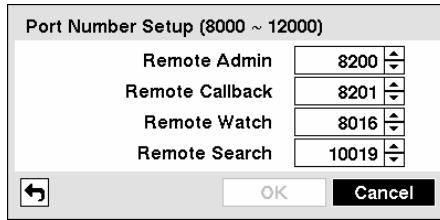

Figure 44 — Port Numbers setup screen

Change the numbers by highlighting them and using the Up and Down arrow buttons to increase or decrease the number.

The factory default Port settings are:

Remote Admin:	8200
Remote Callback:	8201
Remote Watch:	8016
Remote Search:	10019

**NOTE:** The system restarts automatically after changing the port settings.

**NOTE:** Do NOT use the same port number for two different programs, otherwise, the DVR cannot be connected with the PC running RAS.

**CAUTION:** When changing the port settings, you must change the port settings on the PC running RAS as well. Refer to the RAS manual for details.

Selecting DHCP from the Type and highlighting Save button reads the current IP address of the DVR configured by DHCP (Dynamic Host Configuration Protocol) network.

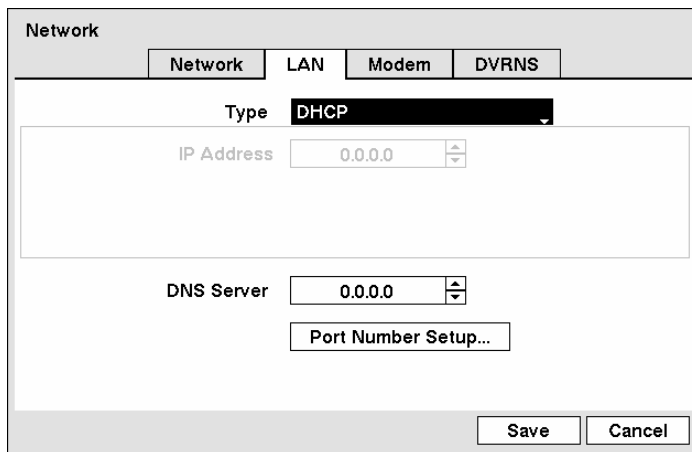

Figure 45 — LAN (DHCP) setup screen.

Selecting ADSL (with PPPoE) allows you to set up the ADSL network.

**NOTE: ADSL and modem cannot be configured at the same time. If the DVR is configured by modem, the ADSL (with PPPoE) will not be selected.**

The screenshot shows a 'Network' configuration window with four tabs: 'Network', 'LAN', 'Modem', and 'DVRNS'. The 'LAN' tab is selected. The 'Type' dropdown menu is set to 'ADSL (with PPPoE)'. Below this, there are several input fields: 'IP Address' (0.0.0.0), 'ID' (empty), 'Password' (empty), and 'DNS Server' (0.0.0.0). A 'Port Number Setup...' button is located below the DNS Server field. At the bottom right, there are 'Save' and 'Cancel' buttons.

Figure 46 — LAN (ADSL) setup screen.

Highlight the box beside **ID** and press the  button. A virtual keyboard appears allowing you to enter the ID for ADSL connection.

Highlight the box beside **Password** and press the  button. A virtual keyboard appears allowing you to enter the password for ADSL connection.

**NOTE: Entering the *ID* and *Password* and highlighting *OK* reads the current IP address of the DVR configured by the ADSL network.**

**NOTE: If the DVR is configured for DHCP or an ADSL network, the IP address of the DVR might change whenever the unit is turned on.**

## Modem Setup

Highlight the Modem tab, and the Modem screen displays.

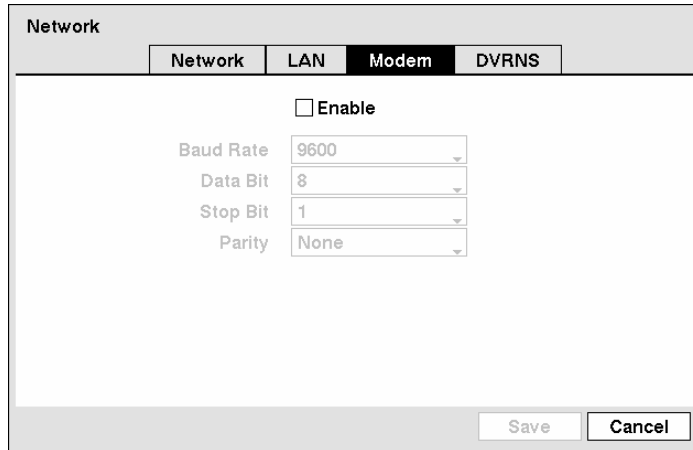

The screenshot shows a window titled "Network" with four tabs: "Network", "LAN", "Modem", and "DVRNS". The "Modem" tab is selected and highlighted. Below the tabs, there is a checkbox labeled "Enable" which is currently unchecked. Underneath the checkbox are four dropdown menus: "Baud Rate" (set to 9600), "Data Bit" (set to 8), "Stop Bit" (set to 1), and "Parity" (set to None). At the bottom right of the window are two buttons: "Save" and "Cancel".

Figure 47 — Modem setup screen.

**NOTE: If the RS232 port is in use for remote control, networking cannot be configured for a modem.**

Highlight **Enable** and press the  button to toggle between On and Off. You will only be able to change the settings if Modem is enabled.

Highlight the box beside **Baud Rate** and press the  button. A list of baud rates ranging from 300 to 115,200 appears.

Highlight the box beside **Data Bit** and press the  button. Choose between 7 bit and 8 bit formats.

Highlight the box beside **Stop Bit** and press the  button. Choose between 1 and 2 Stop Bits.

Highlight the box beside **Parity** and press the  button. A drop-down list appears. You can select from None, Odd or Even parity.

## DVRNS Setup

Highlight the DVRNS tab, and the DVRNS screen displays.

Figure 48 — DVRNS setup screen.

Highlight Use DVR Name Service and press the  button to toggle between On and Off.

**NOTE: The DVRNS (DVR Name Service) allows the DVR to use Dynamic IP addresses for remote connection. When this feature is On, you can access your DVR remotely using the DVR name instead of IP address. For the DVRNS feature, the DVR should be registered on the DVRNS server.**

Highlight the box beside DVRNS Server and press the  button. A virtual keyboard appears allowing you to enter the IP address or domain name of the DVRNS server.

**NOTE: You will need to get the IP Address or domain name of the DVRNS Server from your network administrator.**

**NOTE: You can use the domain name instead of IP address if you already set up the DNS Server when setting LAN.**

Highlight the box beside Port and press the  button. Set the port number of the DVRNS server using the Up and Down arrow buttons to increase or decrease the numbers.

Highlight Use NAT and press the  button to toggle between On and Off..

**NOTE: When using the NAT (Network Address Translation) device, refer to the NAT manufacturer' instructions for the proper network settings.**

Highlight the box beside DVR Name and press the  button. A virtual keyboard appears allowing you to enter the DVR name to be registered on the DVRNS server.

Highlight the Check box and press the  button to check whether or not the name you entered can be used.

**NOTE: The DVR name you entered should be checked by selecting *Check*, otherwise the DVRNS changes will not be saved.**

**NOTE: When entering no name or a name already registered on the DVRNS server, an error message displays.**

Highlighting Save and pressing the  button registers the DVR on the DVRNS server. Proper DVRNS settings will display the help desk information of the DVRNS server in the box beside Help Desk.

**CAUTION: If you want to use the same DVR name registered on the DVRNS server after initializing the system using the factory reset, you need to contact the DVRNS server manager. Please record and save the help desk information before factory reset.**

**CAUTION: The DVRNS registration will be limited to one DVRNS server. The DVR cannot be registered to multiple DVRNS servers. Please contact your network administrator when you want to register the DVR to another DVRNS server.**

You can save your Network changes by highlighting Save and pressing the  button. Selecting Cancel exits the screen without saving the changes.



## Notification Setup

The DVR can be set up to send an email or to contact a computer running RAS (Remote Administration System) when an event occurs.

Highlight **Notification** in the Network menu and press the **↩** button. The Notification screen displays. You will be able to change the Mail and Callback settings.

Figure 49 — Notification Mail setup screen.

Highlight **Enable** and press the **↩** button to toggle between On and Off. You will only be able to change the settings if Mail is enabled.

Highlight the box beside **SMTP Server** and press the **↩** button. Use the arrow buttons to enter the SMTP Server IP address obtained from your system administrator.

Highlight the box beside **Port** and press the **↩** button. Use the arrow buttons to enter the SMTP Server port number obtained from your system administrator. The default port number is 25.

Highlight the box beside **Authentication** and press the **↩** button. An Authentication screen appears. Highlight **Use** and press the **↩** button to toggle between On and Off. Highlight the box beside **User / Password** and press the **↩** button. A virtual keyboard appears allowing you to enter the user ID and password.

Figure 50 — Authentication setup screen.

Highlight the box beside **Sender** and enter the sender's e-mail address. Use the virtual keyboard to enter the e-mail address.

**NOTE: The e-mail address must include the “@” character to be a valid address.**

Highlight the box beside **Recipient** and enter the recipient's e-mail address. Use the virtual keyboard to enter the e-mail address.

Highlight the **Callback** tab, and the Callback screen displays.

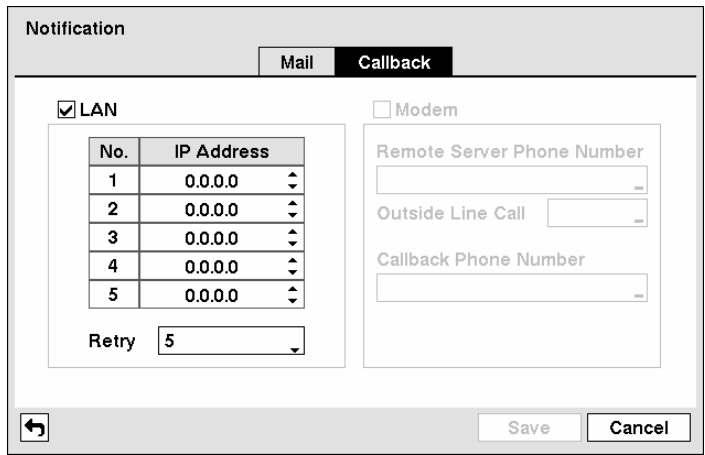

Figure 51 — Notification Callback setup screen.

Highlight **LAN** and press the  button to toggle between On and Off. When LAN is turned On you can change the IP addresses.

Highlight the **IP Address** box that you want to change and press the  button. Enter the IP address of the computer you want contacted during an event. You can enter up to five IP addresses.

Highlight the box beside **Retry** and enter the number of times you would like the DVR to try contacting the computer. You can select from 1 to 10 retries.

If the modem was enabled in the Network screen, you can set up the DVR to contact a computer running RAS. Highlight **Modem** and press the  button to toggle between On and Off. When Modem is turned On you can enter a phone number.

Highlight the box beside **Remote Server Phone Number** and enter the telephone number of the computer running RAS.

Highlight the box beside **Outside Line Call** and enter any numbers that must be dialed for an outside line for your telephone system; for example, “9”.

Highlight the box beside **Callback Phone Number** and enter the telephone number of the DVR.

You can save your Notification changes by highlighting **Save** and pressing the  button. Selecting **Cancel** exits the screen without saving the changes.

## Configuring Devices

You can configure the video, audio, alarm, display and remote control devices connected to the DVR.



Figure 52 — Device menu.

### Camera Setup Screen

Highlight **Camera** in the **Devices** menu and press the  button. The **Camera** setup screen appears.

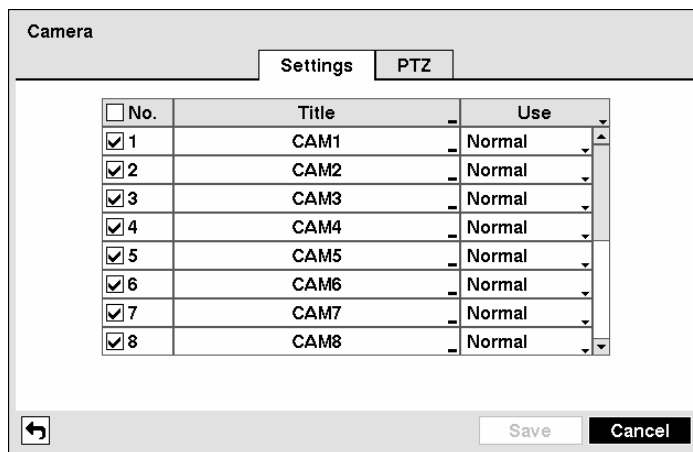

Figure 53 — Camera setup screen.

You can turn the camera number On or Off, and you can change the Title of each camera using the virtual keyboard. You can also determine which cameras will display on the monitors by selecting **Normal**, **Covert 1** or **Covert 2** from a drop-down list in the **Use** column.

**NOTE:** When selecting the *Covert 1*, the DVR displays the camera title and status icons on the covert video. When selecting the *Covert 2*, the DVR displays only camera title on the covert video.

**NOTE:** If a user who does not have *Covert Camera View* authority, the user cannot view video from cameras set to *Covert 1* or *Covert 2* in both the live monitoring and playback modes.

Highlight the PTZ tab, and the PTZ setup screen displays.

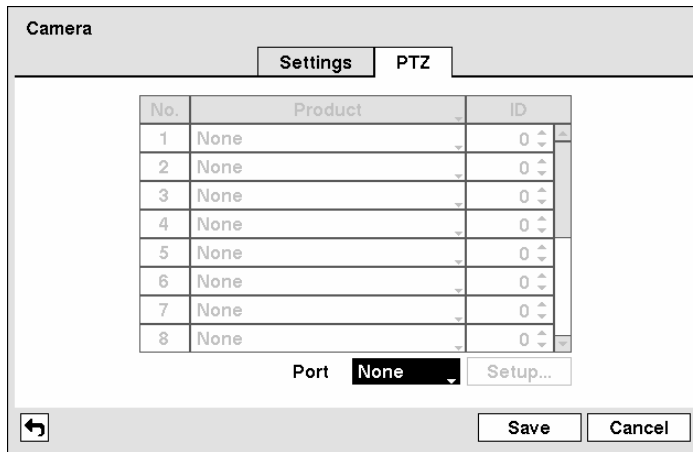



Figure 54 — Camera PTZ setup screen.

**NOTE:** You will only be able to set up PTZ devices if the PTZ port is set to RS232 or RS485. You will not be able to use a modem if you are using the RS232 port for PTZ control.

Highlight the box in the Product column for the PTZ camera you wish to configure and press the button. A list of PTZ devices appears. Select your camera from the list and press the button. You will need to connect the camera to the RS232 or RS485 connector on the back of the DVR following the camera manufacturer's instructions.



Figure 55 — PTZ Device list.

You can assign IDs to each camera by highlighting the box under the ID heading and pressing the  button. Change the number by highlighting it and using the Up and Down arrow buttons to increase and decrease the number. The PTZ ID number can be set from 0 to 256.

Highlight the Setup... box and press the  button. The Port Setup window appears.

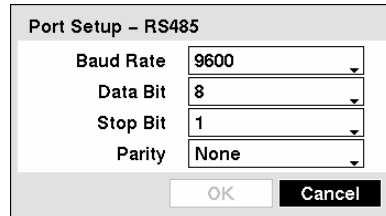

Port Setup - RS485

Baud Rate: 9600

Data Bit: 8

Stop Bit: 1

Parity: None

OK Cancel

Figure 56 — Port Setup window.

Configure the port's setting based on the PTZ camera manufacturer's instructions.

You can save your Camera changes by highlighting Save and pressing the  button. Selecting Cancel exits the screen without saving the changes.

## Audio Setup Screen

Highlight Audio in the Devices menu and press the  button. The Audio setup screen appears.

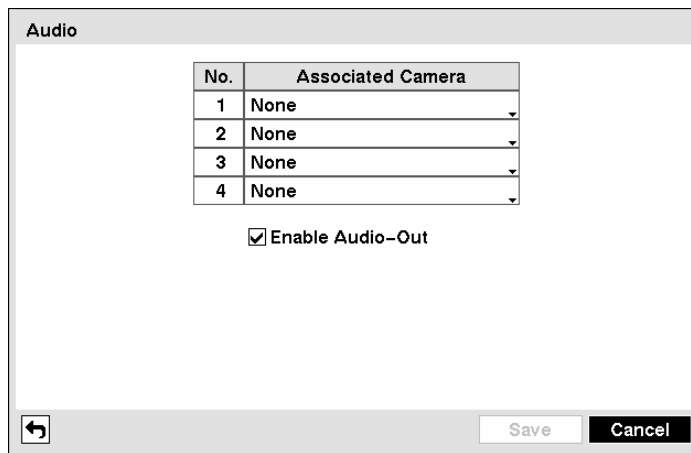

Audio

No.	Associated Camera
1	None
2	None
3	None
4	None

Enable Audio-Out





 Save Cancel

Figure 57 — Audio setup screen.

The DVR can record up to four audio inputs. Highlight the box beside the input and press the  button. A list of cameras appears, and you can select which camera you want associated with that audio input.

Highlight Enable Audio-Out and press the  button. This toggles between enabling and disabling audio out.

**NOTE: The DVR will NOT record audio when the recording speed is set to less than 1 ips.**

You can save your Audio changes by highlighting Save and pressing the  button. Selecting Cancel exits the screen without saving the changes.

### Alarm-Out Screen

Highlight Alarm-Out in the Devices menu and press the  button. The Alarm-Out screen allows you to change the settings and establish a schedule for each alarm output from the DVR.

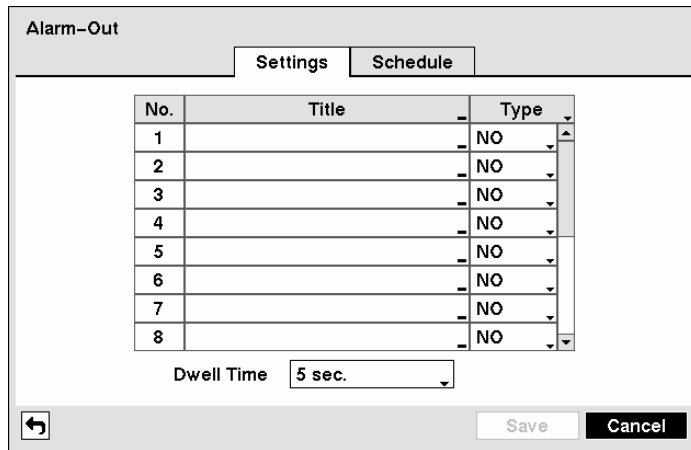



Figure 58 — Alarm-Out Settings screen.

Each alarm output can be given its own title by highlighting the box under the Title heading and pressing the  button. A virtual keyboard appears allowing you to enter the title.

Highlighting the boxes under the Type heading allows to set the alarm output for NO or NC (normally open or normally closed).

Highlighting the box beside Dwell Time and pressing the  button allows you to set the dwell time of the alarm output. Dwell times rang from 5 seconds to 15 minutes.

Highlighting the Schedule tab causes the Schedule screen to display.

No.	Day	Range	Mode	Channels	X
1	All	00:00 ~ 24:00	Event	1~16, Beep	X
					X
					X
					X
					X
					X
					X
					X
					X
					X

+

← Save Cancel

Figure 59 — Alarm-Out Schedule screen.

You can add and edit alarm output schedules on this screen. Highlight the + and press the button to add a schedule. Highlighting the boxes under the Column heading and pressing the button allows you to edit the information in those boxes.

The **Day** box allows you to select the days that the alarm schedule will be active. The choices are: Sun, Mon, Tue, Wed, Thu, Fri, Sat, M~F, Hol and All.

The **Range** box allows you to set the time that the alarm schedule will be active in 30-minute increments from 00:00 to 24:00.

The **Mode** box allows you to set how the alarm reacts during the scheduled time. When set to **On**, the Alarm-Out is active during the scheduled time. When set to **Event**, the Alarm-Out is only active when there is an Event during the scheduled time.

The **Channels** box allows you to set which alarm outputs will be active. You can also select the DVR's internal buzzer.

The **X** box allows you to delete an alarm output schedule. You will be asked to confirm whether or not you really wish to delete the schedule.

You can save your Alarm-Out changes by highlighting **Save** and pressing the button. Selecting **Cancel** exits the screen without saving the changes.

## Display Screen

Highlight Display in the Devices menu and press the  button. The Display screen allows you to select what information will be displayed on the monitor.

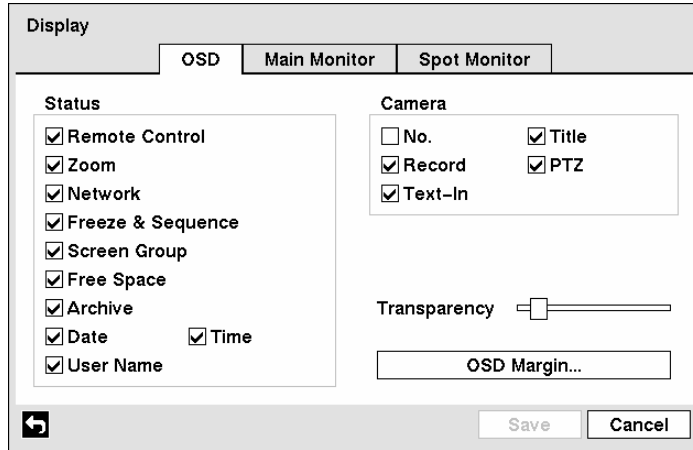











Figure 60 — Display OSD screen.

Highlighting an item and pressing the  button toggles that item On and Off. When an item is On, there is a checkmark in the box beside it. The following items can be turned On or Off:

- **Remote Control** — The icon  displays when the DVR can be controlled by the infrared remote control.
- **Zoom** — The icon  displays on the enlarged video.
- **Network** — The icon  displays when the unit is connected to a network via either Ethernet or modem.
- **Freeze & Sequence** — The icon  displays while in the Freeze mode, and the  displays while in the Sequence mode.
- **Screen Group** — The number of screen group displays when the DVR is not in the 4x4 display mode of the 16-channel DVR, and 3x3 mode of the 9-channel DVR.
- **Free Space** — The icon  displays when the DVR is in the Recycle mode, and the percentage of available storage space displays when the DVR is not in the Recycle mode.
- **Archive** — The icon  displays when the DVR is archiving recorded data.
- **Date / Time** — The current date and time information displays.
- **User Name** — The name of the current user logged in displays.
- **Camera No.** — The camera number displays at the top-left corner of each camera screen.
- **Camera Title** — The camera title displays at the top-left corner of each camera screen.
- **Record** — The record related icons display on each camera screen.
- **PTZ** — The icon  displays on each PTZ camera screen.
- **Text-In** — The text input strings display on the screen.



You can adjust the transparency of the setup screens by highlighting Transparency and using the Left and Right arrow buttons.

Highlighting OSD Margin... and pressing the  button displays how OSD text will be displayed on the monitor. You can adjust the horizontal and vertical margins so that text and icons will not be hidden beyond the edges of the monitor.

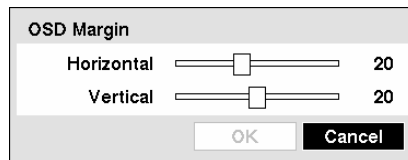

Figure 61 — OSD Margin screen.

Highlight the Main Monitor tab to switch to the Sequence screen.

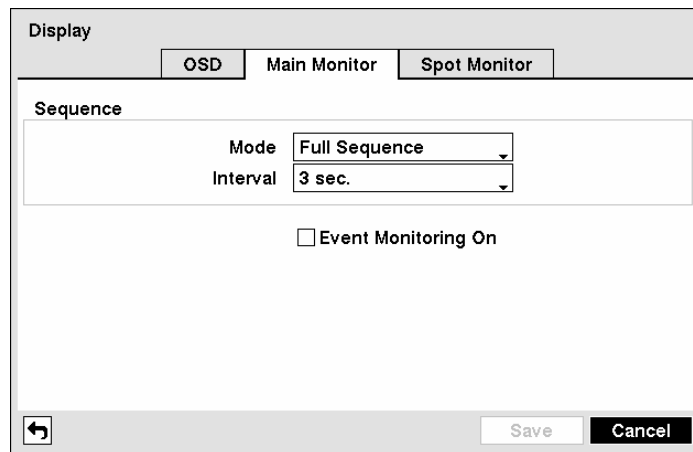



Figure 62 — Main Monitor screen.

You can adjust the display dwell time for each camera displayed on the main monitor. Highlight the box beside Mode and press the  button. You can select between Full Sequence and Cameo Sequence.



Pressing the **SEQUENCE** button causes the DVR to sequence cameras, and the DVR can sequence cameras in two modes: “Full” and “Cameo”. In the Full mode, the DVR sequences through the cameras and displays them full screen. In the Cameo mode, the bottom right window in a multi-screen format sequences through the cameras.

**NOTE: Any cameras that are Off, have lost video or are set to Covert (unless the user has authority to view covert cameras) will be excluded from the Cameo sequence.**

You can define the screen layout in a variety of formats and set the DVR to sequence through the different screen layouts (pages) so that all the cameras will be displayed. You can also set up the DVR to display one camera or a group of cameras all the time while cycling through the remaining cameras in a “cameo” window. This can be done with one camera displayed full screen while displaying the cameo window as a PIP (picture in picture), or displaying the cameras in a grid pattern with the bottom right window as the cameo.

**NOTE: Sequence cannot be used in the 4x4 display mode of the 16-channel, and 3x3 mode of the 9-channel DVR.**

You can adjust the display dwell time by highlighting the box beside Interval and pressing the  button. You can select dwell intervals ranging from 1 second to 1 minute.

Highlight Event Monitoring On and press the  button. Pressing the  button toggles between On and Off. When it is On, the DVR will display the camera associated with the event when an event occurs.

Highlight the Spot Monitor tab to switch to the Spot Monitor screen.

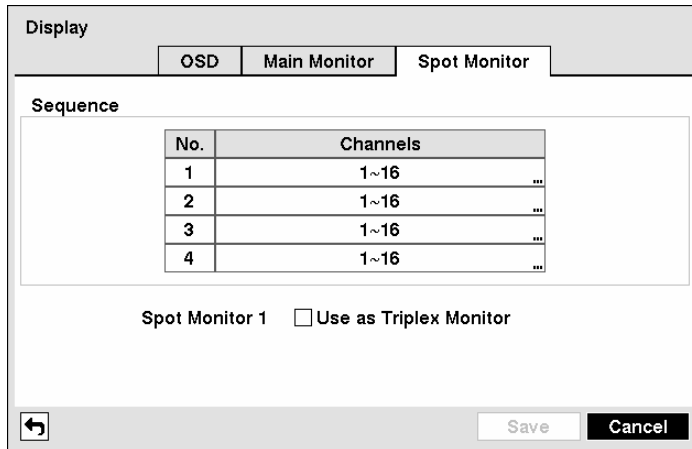





Figure 63 — Spot Monitor screen.

You can define which cameras display sequentially on the Spot Monitors. Highlight the box in the Channels column for the desired Spot Monitor and press the  button.

Highlight Spot Monitor 1 – Use as Triplex Monitor and press the  button. Pressing the  button toggles between On and Off. When it is On, the DVR will display live video on the SPOT monitor 1 as shown on the main monitor while in the Search mode (Pro Model only).

You can save your Display settings by highlighting Save and pressing the  button. Selecting Cancel exits the screen without saving the changes.

## Remote Control Screen

Highlight **Remote Control** in the **Devices** menu and press the  button. The **Remote Control** setup screen allows you to select a port and make correct settings for a remote keyboard.



The image shows a screenshot of the 'Remote Control' setup screen. The window has a title bar that says 'Remote Control'. Inside the window, there are two main sections. The first section is labeled 'Port' and contains a dropdown menu currently set to 'None' and a 'Setup...' button to its right. The second section is labeled 'Remote Control Product' and contains a dropdown menu currently set to 'HID-2404 Series'. At the bottom of the window, there is a navigation bar with a left arrow button on the left, a 'Save' button in the center, and a 'Cancel' button on the right.

Figure 64 — Remote Control setup screen.

Highlight the box beside **Port** and select from **None**, **RS232** and **RS485**. If the **RS232** port and **RS485** port are in use for **PTZ** control, networking or text input, the remote keyboard cannot be configured.

Highlight **Setup...** and select the correct **Baud Rate**, **Parity**, **Data Bits** and **Stop Bits** for the device you are connecting to the **DVR**.

Highlight the box beside **Remote Control Product** and select the device from the list.

You can save your **Remote Control** settings by highlighting **Save** and pressing the  button. Selecting **Cancel** exits the screen without saving the changes.

## Recording Settings

Your DVR offers a variety of flexible recording modes. You can set it up to record all the time or to only record events. It can be set up to continue recording once the hard disk drive is full by recording over the oldest video, or you can set it up to alert you when the hard disk is full and stop recording.



Figure 65 — Record menu.

### Record Screen

Highlight **Record** in the Record menu and press the  button. The **Record** setup screen appears.

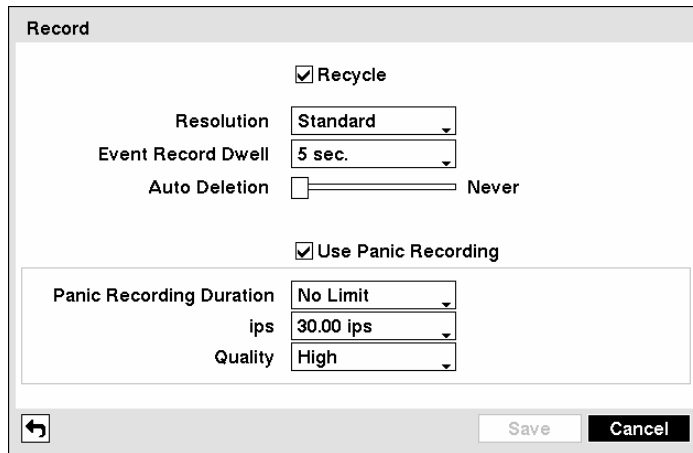



Figure 66 — Record setup screen.

Highlighting **Recycle** and pressing the  button toggles between On and Off. In the Recycle mode, the DVR records over the oldest video data once all available storage space has been used. When Recycle is turned off, the DVR stops recording once all available storage space has been used.

Highlight the **Resolution** box and select from **High** and **Standard**. All other variables being equal; Selecting High resolution will decrease the recording and playback speed by half that of Standard resolution.

Highlight the **Event Record Dwell** box and set the length of time you would like to record for the associated event. You can set the dwell from 5 seconds to 15 minutes. Refer to *Event Actions* screen in this chapter for the information of event recording.

Highlight the slide bar beside **Auto Deletion**, and use the Left and Right arrow buttons to adjust the length of time recorded data will be kept from 1 to 99 days. The DVR will delete video recorded earlier than user-defined period at 24:00 o'clock and also when the system reboots or the user changes the Auto Deletion settings. Selecting **Never** will disable the Auto Deletion function.

Highlighting **Use Panic Recording** and pressing the  button toggles between On and Off.

Highlight the **Panic Recording – Duration** box and set the duration of panic recording. The panic recording will be stopped automatically according to the preset duration as long as the **PANIC** button is not pressed to stop the panic recording. You can set the dwell from 5 minutes to 1 hour. Select **No Limit** if you want to stop panic recording manually.

Highlighting the **Panic Recording – ips** and pressing the  button allows you to set the images per second for Panic recording. You can select from 0.10 to 30.0 images per second.

Highlighting the **Panic Recording – Quality** and pressing the  button allows you to set the recorded image quality for Panic recording. You can select from: **Very High**, **High**, **Standard** and **Low**.

You can save your Record settings by highlighting **Save** and pressing the  button. Selecting **Cancel** exits the screen without saving the changes.

## Schedule Screen

Highlight **Schedule** in the Record menu and press the  button, and the Schedule setup screen appears.

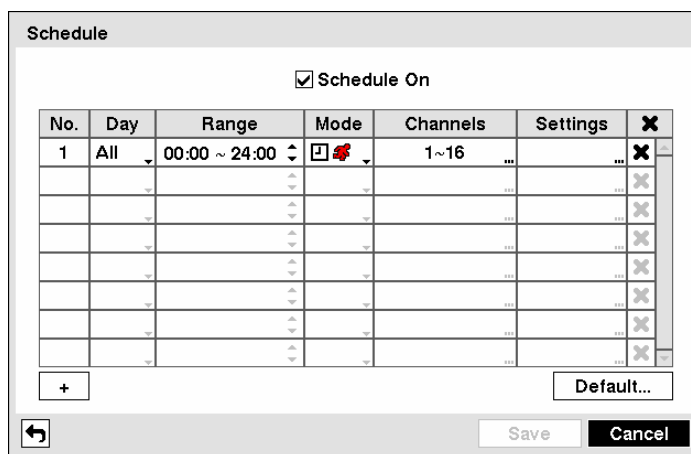



No.	Day	Range	Mode	Channels	Settings	X
1	All	00:00 ~ 24:00		1~16	...	X
						X
						X
						X
						X
						X
						X
						X

Schedule On

Figure 67 — Schedule setup screen.

You can program the DVR to record only during certain times based on time, day of the week, and holidays. The smallest time segment you can use is 30 minutes.

Highlighting **Schedule On** and pressing the  button toggles between On and Off. In the Schedule On mode, the DVR records video based on the schedule established in the Schedule screen. When turning Off Schedule recording, you will be asked to confirm your decision, and  displays at the top-left corner of each camera screen. Panic recording will function even when Schedule is turned off.  displays during panic recording.



Highlight the + and press the  button to add a schedule item.





Highlight the box under the **Day** heading and press the  button to change the days that the scheduled recording will take place. Choose from: Sun, Mon, Tue, Wed, Thu, Fri, Sat, M~F, Hol and All.



Highlight the box under the **Range** heading and press the  button to change the time range that the scheduled recording will take place. The smallest time segment you can use is 30 minutes.

Highlight the box under the **Mode** heading and press the  button to change the recording mode that will be used. Choose from: No Record, Time, Event and Time & Event.

When the DVR is in the **No Record** mode, it will not record during the preset day and time range as long as the **PANIC** button is not pressed. Use the **No Record** mode when you do NOT want the DVR to record during certain times.

When the DVR is in the **Time** mode, the  icon displays at the top-left corner of the screen. The DVR will record and displays the  icon at the top-left corner of the screen during the scheduled times.

When the DVR is in the **Event** mode, the red  icon displays at the top-left corner of the screen. The DVR will record and displays the  icon at the top-left corner of the screen when any event occurs. When the DVR is in the **Pre-Event** recording mode, the yellow  icon displays when there is no event, and the DVR is not recording. When the DVR is in the **Pre-Event** mode, the red  and  display when any event occurs and the DVR starts recording.

When the DVR is in the **Time & Event** mode, the DVR will follow the Time settings and the  icon displays. The DVR follows the Event settings and the  icon displays.

Highlight the box under the **Channels** heading and press the  button to select which cameras will be recorded.

Highlight the box under the **Settings** heading and press the  button to define the recording settings. You can set the ips and Quality of the recording for any modes you set up in the Mode column. If you do not set the ips and Quality in the Settings column, the DVR will follow the default settings. See below for details.

Highlight the box under the **X** heading and press the  button to delete the recording settings. You will be asked to confirm that you want to delete the settings.

Highlight **Default...** and press the  button. The Default screen appears.

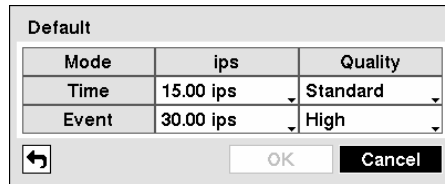

Default		
Mode	ips	Quality
Time	15.00 ips	Standard
Event	30.00 ips	High





Navigation buttons:  OK Cancel

Figure 68 — Default setup screen.

Highlighting boxes under **ips** and pressing the  button allows you to set the images per second for Time and Event recording. You can select from 0.10 to 30.0 images per second.

Highlighting boxes under **Quality** and pressing the  button allows you to set the recorded image quality for Time and Event recording. You can select from: Very High, High, Standard and Low.

You can save your changes by highlighting **Save** and pressing the  button. Selecting **Cancel** exits the screen without saving the changes.

## Pre-Event Screen

Highlight **Pre-Event** in the Record menu and press the  button, and the Pre-Event setup screen appears. If you do not have Event set up in the Record Schedule, a message will display alerting you to this fact.

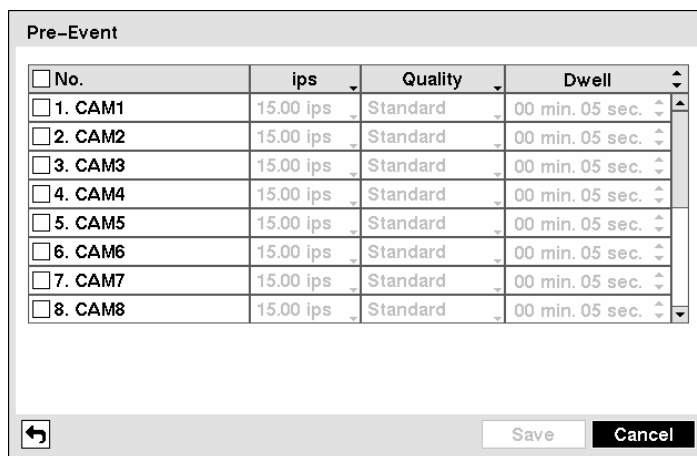

<input type="checkbox"/> No.	ips	Quality	Dwell
<input type="checkbox"/> 1. CAM1	15.00 ips	Standard	00 min. 05 sec.
<input type="checkbox"/> 2. CAM2	15.00 ips	Standard	00 min. 05 sec.
<input type="checkbox"/> 3. CAM3	15.00 ips	Standard	00 min. 05 sec.
<input type="checkbox"/> 4. CAM4	15.00 ips	Standard	00 min. 05 sec.
<input type="checkbox"/> 5. CAM5	15.00 ips	Standard	00 min. 05 sec.
<input type="checkbox"/> 6. CAM6	15.00 ips	Standard	00 min. 05 sec.
<input type="checkbox"/> 7. CAM7	15.00 ips	Standard	00 min. 05 sec.
<input type="checkbox"/> 8. CAM8	15.00 ips	Standard	00 min. 05 sec.

Navigation buttons:  Save Cancel

Figure 69 — Pre-Event setup screen.

When the DVR is in the Event Record mode it is possible to have it record images before the event occurs. The Pre-Event screen allows you to define how to handle pre-event recording.

You can turn individual cameras On or Off for pre-event recording. The image speed can be set from 0.10 to 30.00 ips (25.00 ips PAL), and image quality can be selectable from Very High, High, Standard and Low.

You can set the amount of time to record prior to the event by adjusting the Dwell. You can set the Dwell from 5 seconds to 30 minutes. The longer the dwell set, the fewer maximum ips can be set.

**NOTE: When the DVR is in the Time or Time & Event mode, it ignores the pre-event settings and follows the time settings.**

You can save your changes by highlighting Save and pressing the  button. Selecting Cancel exits the screen without saving the changes.

### Archive Screen

Highlight Archive in the Record menu and press the  button, and the Archive setup screen appears.

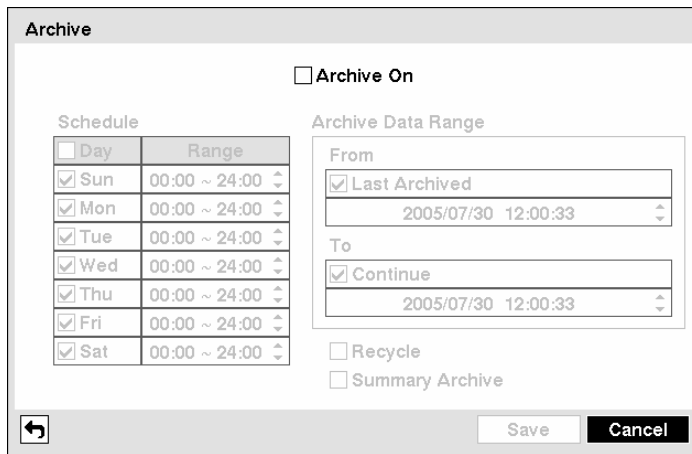

Figure 70 — Archive setup screen.

Highlight Archive On and press the  button to toggle between On and Off.

**NOTE: If you have not set up a storage device for archiving, a message appears notifying you of this.**

Select the Days and Time Range you want archived.



You can accept the Archive Data Range by leaving the default checkmarks in the **Last Archived** and **Continue** boxes. If you wish to enter specific times and dates in **From** and **To**, toggle the checkmarks **Off** and then enter the time and date.

Highlight **Recycle** and press the  button to toggle between **On** and **Off**. When **Recycle** is **On** and the storage device is full, the newest archived video data will overwrite the oldest archived data. When **Recycle** is **Off**, the DVR will stop archiving video data until more space is made available.

Highlight **Summary Archive** and press the  button to toggle between **On** and **Off**. When **Summary Archive** is **On**, the DVR does not archive recorded video in full, but archives 1 or 2 ips from each channel. This will allow the DVR to archive more recorded video and increase archive speed as well.

**NOTE: If 15 or less ips have been recorded per channel 1 ips will be archived, and if 30 ips have been recorded per channel 2 ips will be archived. If 16 to 29 ips have been recorded per channel, 1 or 2 ips will be archived depending on the structure of video frame. The DVR will archive recorded video in full when 1 or less ips has been recorded per channel.**

**NOTE: The archiving speed might be slower than the recording speed when the large quantity of recorded data is being archived. In this case, the old data can be overwritten by the latest data being recorded. To prevent unwanted data overwriting please use the Summary Archive function, or set the recorded image quality to Standard during the archiving process (PRO Model only).**

You can save your changes by highlighting **Save** and pressing the  button. Selecting **Cancel** exits the screen without saving the changes.

## Event Settings

Your DVR can be set to detect many different events. You can also determine how it reacts to these events.

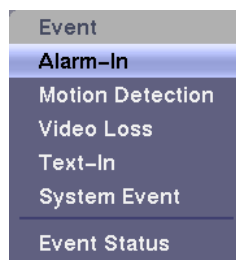



Figure 71 — Event menu.

## Alarm-In Screen

Highlight Alarm-In in the Event menu and press the  button. The Alarm-In setup screen appears.

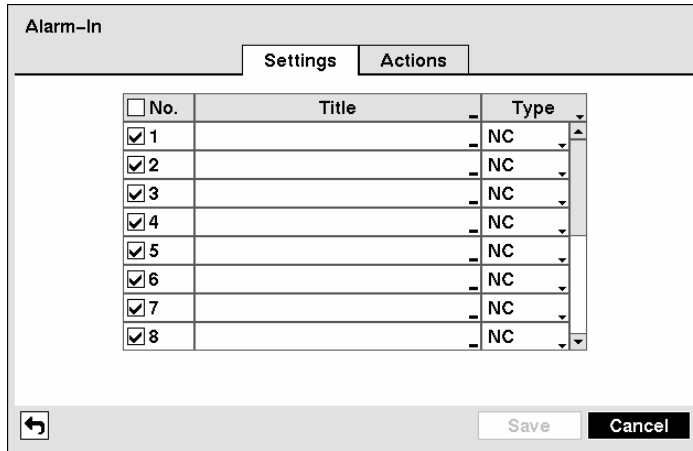



Figure 72 — Alarm-In Settings screen.

The alarm terminal strip on the back of the DVR has inputs associated with each alarm. You can set up each input on the Alarm-In screen. You can turn each input On or Off by highlighting the alarm number and pressing the  button.

Each input can be given a title. Highlight the desired Title box and press the  button. A virtual keyboard appears allowing you to enter a title name.

Each input can be set as NO (normally open) or NC (normally closed).

Highlight the Actions tab, and the Actions setup screen appears.

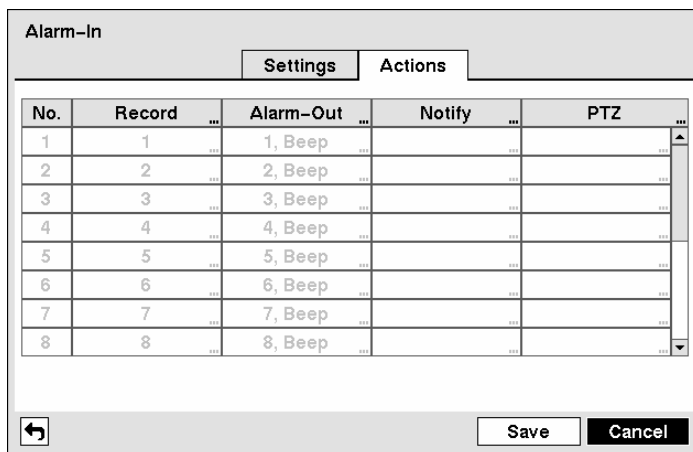

Figure 73 — Alarm-In Actions screen.

You can set the actions the DVR will take whenever it senses an input on one of its alarm input connectors.

Highlight the desired box under the **Record** heading, and press the  button. A list of cameras appears. Select the cameras that you want the DVR to record whenever it detects an input on the associated alarm input.

**NOTE: For the Record action, the camera you select should be set to the Event or Time & Event recording mode in the Record Schedule setup screen.**

Highlight the desired box under the **Alarm-Out** heading, and press the  button. A list of Alarm Outputs and Beep appear. Select the Alarm Output connectors that you would like to activate whenever the DVR detects an input on the associated alarm input. You can also set the DVR's internal buzzer to sound.

**NOTE: For the Alarm-Out action, the alarm output and beep you select should be set to the Event mode in the Alarm-Out setup screen (Schedule tab).**

Highlight the desired box under the **Notify** heading, and press the  button. The Alarm-In Notify menu appears.

Alarm-In : Notify	
<input type="checkbox"/>	Notification
<input type="checkbox"/>	Mail : <None>
<input type="checkbox"/>	Modem : <None>
<input type="checkbox"/>	LAN 1 : <None>
<input type="checkbox"/>	LAN 2 : <None>
<input type="checkbox"/>	LAN 3 : <None>
<input type="checkbox"/>	LAN 4 : <None>
<input type="checkbox"/>	LAN 5 : <None>
<input type="checkbox"/>	Alert Window
<input type="button" value="OK"/> <input type="button" value="Cancel"/>	

Figure 74 — Alarm-In Notify menu.

You can toggle the entire list On and Off by highlighting **Notification** and pressing the  button. You can toggle the individual items On and Off by highlighting that item and pressing the  button. Highlight **OK** and press the  button to accept your changes.

**NOTE: For the Notify action, the notify item you select should be enabled in the Notification setup screen and the DVR should be registered in the RAS (Remote Administration System).**

Highlight the desired box under the **PTZ** heading, and press the  button. A list of PTZ presets appear. Select the preset position for each PTZ camera, where you want PTZ cameras to move to whenever the DVR detects an input on the associated alarm input.

You can save your Alarm-In changes by highlighting **Save** and pressing the  button. Selecting **Cancel** exits the screen without saving the changes.

## Motion Detection Screen

Highlight **Motion Detection** in the Event menu and press the  button. The Motion Detection setup screen appears.

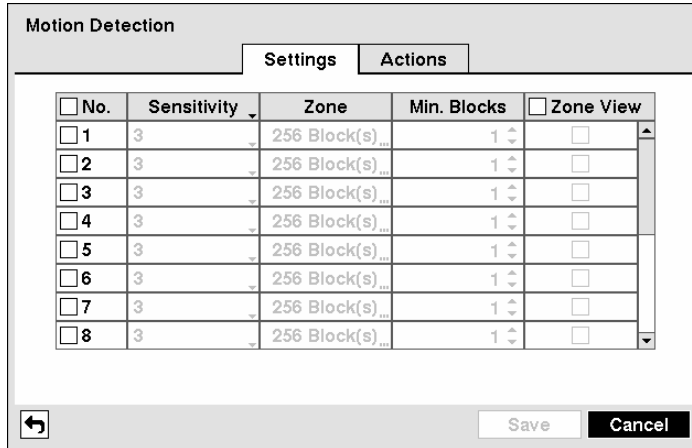



Figure 75 — Motion Detection Settings screen.

Your DVR has built-in video motion detection. Video motion detection can be turned On or Off for each camera.

Highlighting the box under the **Sensitivity** heading allows you to adjust the DVR's sensitivity to motion. There are five settings with 1 being the least sensitive and 5 being the most sensitive.

You can adjust the minimum number of detection blocks that must be activated to trigger a motion alarm. Highlight a box under the **Min. Blocks** heading and adjust the number. Smaller numbers provide greater sensitivity because fewer detection blocks must be activated.

Turning **Zone View** On will allow you to observe how the DVR is reacting to motion. When in the motion viewing mode, the detection zone of video will be displayed in green. Any detected motion within the zone will be displayed in red.

You can define the area of the image where you want to detect motion; e.g., a doorway. Highlight the box under the **Zone** heading, and press the  button. The Motion Detection Zone screen displays.

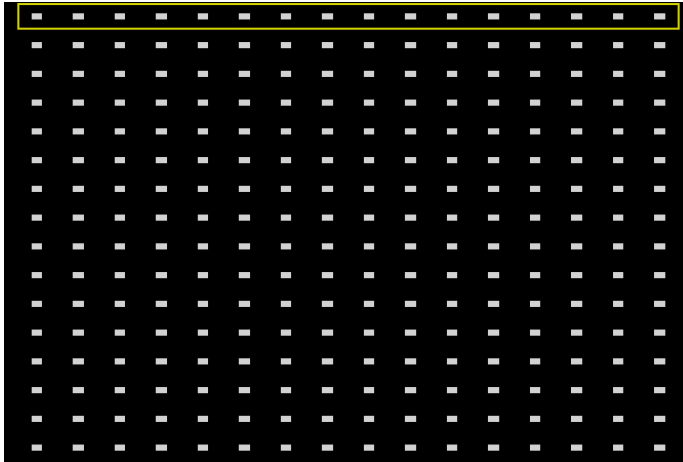

Figure 76 — Motion Detection Zone screen.

The Motion Detection Zone screen is laid over the video for the selected camera. You can set up motion detection zones by selecting or clearing blocks.

**NOTE: You can set up motion zones one block at a time in groups of 8 or 16 individual block groups (9- and 16-channel DVR respectively). A block group is positioned within the image area using the Up and Down arrow buttons, and individual blocks within the block groups are selected or cleared using the camera buttons.**

Press the  button to display the menu screen. The menu on the setup screen has the following functions:



Figure 77 — Motion Detection Zone menu.

**Select** — Activates highlighted blocks to detect motion.

**Clear** — Deactivates highlighted blocks so that they will not detect motion.

**Reverse** — Activates inactive highlighted blocks and deactivates active highlighted blocks.

**Select All** — Activates all blocks to detect motion.

**Clear All** — Deactivates all blocks so that they will not detect motion.

**Reverse All** — Activates inactive blocks and deactivates active blocks.

**OK** — Accepts changes and closes Zone setup.

**Cancel** — Exits Zone setup with saving changes.

Highlight the **Actions** tab and the Motion Detection Actions screen displays.

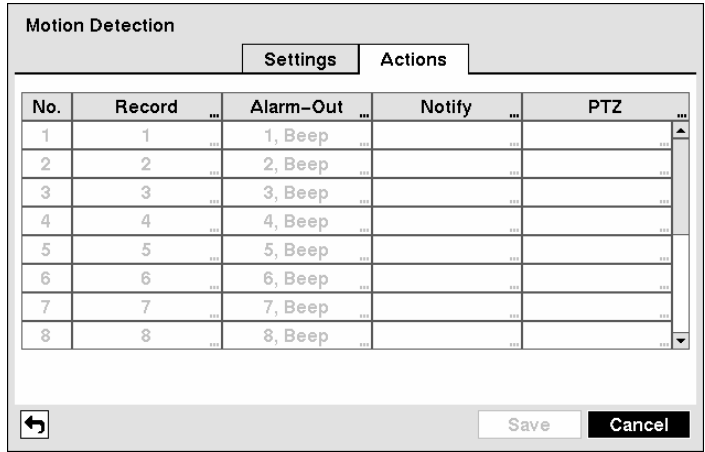

Figure 78 — Motion Detection Actions screen.

The DVR can be set to react to motion detection differently for each camera. Each camera can be associated with another camera, trigger an Alarm-Out connector, sound the DVR's internal buzzer, notify a number of different devices, and/or move PTZ cameras to preset positions.

**NOTE: You can associate multiple cameras with a camera that detects motion.**

Highlight the box under the **Record** heading and press the button. A list of cameras appears. You can associate as many cameras with that camera as you wish. If the DVR detects motion on the selected camera, it starts recording video from all the associated cameras.

**NOTE: For the Record action, the camera you select should be set to the Event or Time & Event recording mode in the Record Schedule setup screen.**

Highlight the box under the **Alarm-Out** heading and press the button. A list of Alarm Outputs appears. You can associate as many Alarm-Outs with that camera as you wish. When the DVR detects motion on the selected camera's input, it triggers output signals on all the associated Alarm-Out connectors. You can also have the DVR's internal buzzer sound if motion is detected on the selected camera.

**NOTE: For the Alarm-Out action, the alarm output and beep you select should be set to the Event mode in the Alarm-Out setup screen (Schedule tab).**

Highlight the box **Notify** heading and press the button. You can toggle the entire list On and Off by highlighting Notification and pressing the button. You can toggle the individual items On and Off by highlighting that item and pressing the button. Highlight OK and press the button to accept your changes.

**NOTE: For the Notify action, the notify item you select should be enabled in the Notification setup screen and the DVR should be registered in the RAS (Remote Administration System).**

Highlight the desired box under the PTZ heading, and press the  button. A list of PTZ presets appear. Select the preset position for each PTZ camera, where you want PTZ cameras to move to whenever the DVR detects motion on the selected camera's input.

You can save your Motion Detection changes by highlighting **Save** and pressing the  button. Selecting **Cancel** exits the screen without saving the changes.

## Video Loss Screen

Highlight **Video Loss** in the Event menu and press the  button. The Video Loss setup screen appears.

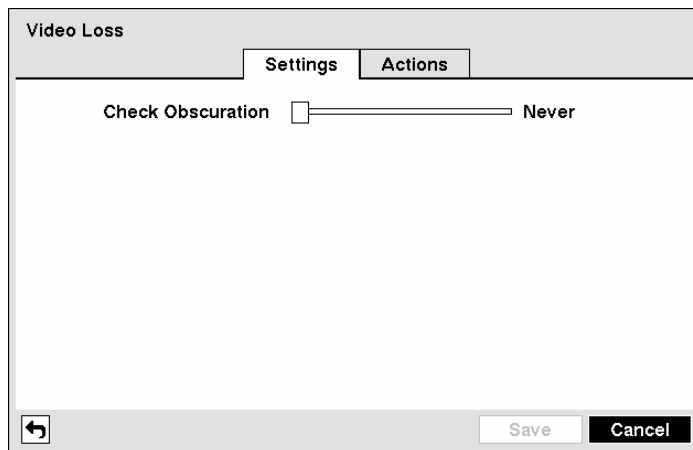

Figure 79 — Video Loss Settings screen.

The DVR checks to see if anything is obscuring the camera. Highlight the slider bar beside **Check Obscuration**, and use the Left and Right arrow buttons to adjust the setting. The sensitivity can be set from **Never** to 255 (extremely sensitive).

Highlight the **Actions** tab and the Video Loss Actions screen displays.

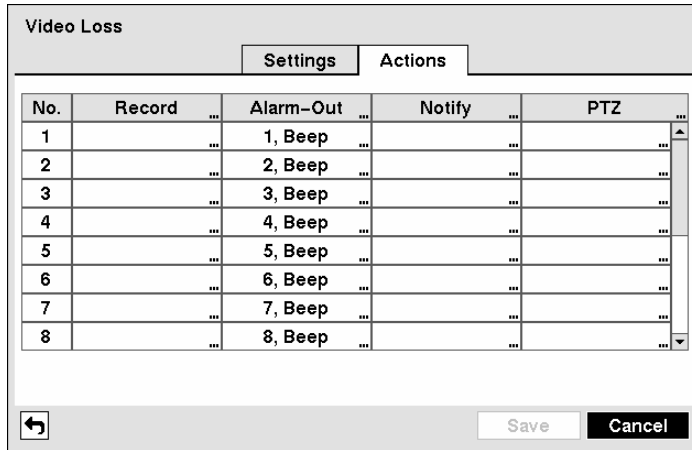

Figure 80 — Video Loss Actions screen.

The DVR can be set to react to video loss differently for each camera. Each camera can be associated with another camera, trigger an Alarm-Out connector, sound the DVR's internal buzzer, notify a number of different devices, and/or move PTZ cameras to preset positions.

Highlight the box under the **Record** heading and press the  button. A list of cameras appears. You can associate as many cameras with that camera as you wish. If the DVR detects video loss on the selected camera, it starts recording video from all the associated cameras.

**NOTE: For the Record action, the camera you select should be set to the Event or Time & Event recording mode in the Record Schedule setup screen.**

Highlight the box under the **Alarm-Out** heading and press the  button. A list of Alarm Outputs appears. You can associate as many Alarm-Outs with that camera as you wish. When the DVR detects video loss on the selected camera, it will trigger output signals on all the associated Alarm-Out connectors. You can also have the DVR's internal buzzer sound if video is lost on the selected camera.

**NOTE: For the Alarm-Out action, the alarm output and beep you select should be set to the Event mode in the Alarm-Out setup screen (Schedule tab).**

Highlight the box under **Notify** heading and press the  button. You can toggle the entire list On and Off by highlighting **Notification** and pressing the  button. You can toggle the individual items On and Off by highlighting that item and pressing the  button. Highlight **OK** and press the  button to accept your changes.

**NOTE: For the Notify action, the notify item you select should be enabled in the Notification setup screen and the DVR should be registered in the RAS (Remote Administration System).**



Highlight the desired box under the PTZ heading, and press the  button. A list of PTZ presets appear. Select the preset position for each PTZ camera, where you want PTZ cameras to move to when the DVR detects video loss on the selected camera's input.

You can save your Video Loss changes by highlighting **Save** and pressing the  button. Selecting **Cancel** exits the screen without saving the changes.

## Text-In Screen

Highlight **Text-In** in the Event menu and press the  button. The **Text-In** setup screen appears.

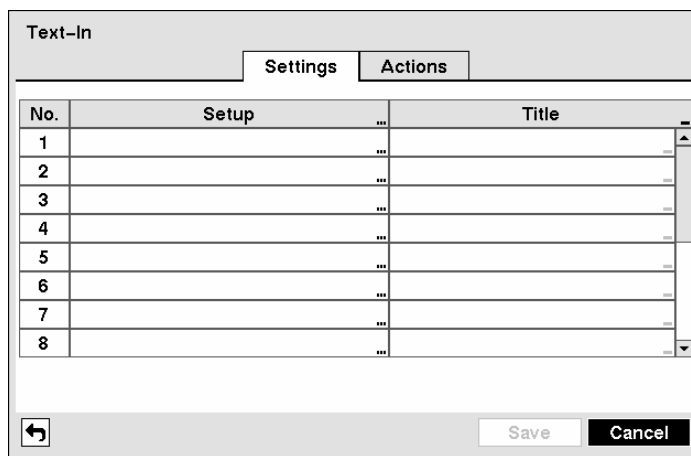

No.	Setup	Title
1	...	
2	...	
3	...	
4	...	
5	...	
6	...	
7	...	
8	...	

Figure 81 — Text-In Settings screen.

The DVR can be set to react to text input from devices such as ATMs (Automated Teller Machines) and POS (Point of Sale; i.e., cash registers). This screen allows you to configure the DVR for each text-in device.

Highlight the box under the **Setup** heading, and press the  button. Selecting **Setup** heading changes all the parameters excluding Port settings of entire text input channels.

**NOTE:** The system performance might be affected when a large quantity of text inputs are detected from several channels at the same time.

Figure 82 — Text-In Device Settings screen.

Highlight the box beside Port, and press the  button. Select from None, RS232, RS485 and USB-Serial (1~8).

**NOTE: If you have set the Port as *None*, you will not be able to make any changes to the screen.**

**NOTE: When using the USB to serial text-in device, do NOT remove the USB cable from the port while the system is running.**

Highlight Setup..., and press the  button. Use the ATM or POS manufacturer's recommended settings when configuring the RS232, RS485 or USB-Serial ports.

Highlight the box beside Text-In Product, and press the  button. Select your device from the list.

**NOTE: The following description is for a *Generic Text Device*. The screen changes for different types of text input devices, and there will be different parameter boxes for you to enter information.**

Highlight the box beside Transaction Start, and press the  button. Use the virtual keyboard to enter the Transaction Start string. Refer to the device manufacturer's documentation for the text string that the device first sends when a transaction starts.

If you want the DVR to react to any character sent from the text input device, you will want to turn On Any Character. Highlight Any Character, and press the  button to toggle between On and Off.

**NOTE: If *Any Character* is turned On, you will not be able to enter any text in the *Transaction Start* box.**

Highlight the box beside **Transaction End**, and press the  button. Use the virtual keyboard to enter the Transaction End string. Refer to the device manufacturer's documentation for the text string that the device sends when a transaction ends.

Highlight the **more line(s)** box, and press the  button. Select the number of additional lines of text that you want the DVR to record. You can choose from 0 to 10.

Highlight the box beside **Line Delimiter**, and press the  button. Use the virtual keyboard to enter the character(s) that the device uses to indicate the end of a line. Special characters can be created using ^ and a capital letter; e.g., ^J for NL (New Line), ^M for CR (Carriage Return). Refer to the device manufacturer's documentation for Line Delimiter character(s).

Highlight the box beside **Ignore String**, and press the  button. Use the virtual keyboard to enter any strings of text that you want the DVR to ignore. Refer to the device manufacturer's documentation for text strings that the device sends during transactions, so you will know which ones you do not want recorded.

Highlight the **Case Sensitive** box, and press the  button to toggle between On and Off. Refer to the device manufacturer's documentation to determine if the text strings are Case Sensitive. If the device distinguishes between upper and lower case letters, make certain the **Case Sensitive** box is turned On.

Highlight the **Actions** tab and the Text-In Actions screen displays.

No.	Record	Alarm-Out	Notify	PTZ
1	...	Beep	...	...
2	...	Beep	...	...
3	...	Beep	...	...
4	...	Beep	...	...
5	...	Beep	...	...
6	...	Beep	...	...
7	...	Beep	...	...
8	...	Beep	...	...

Figure 83 — Text-In Actions screen.

The DVR can be set to react to text input. Text input can be associated with cameras, trigger an Alarm-Out connector, sound the DVR's internal buzzer, notify a number of different devices, and/or move PTZ cameras to preset positions.

Highlight the box beside **Record** and press the  button. A list of cameras appears. You can associate as many cameras with the Text Input as you wish. If the DVR detects text input, it starts recording video from all the associated cameras.

**NOTE: For the Record action, the camera you select should be set to the Event or Time & Event recording mode in the Record Schedule setup screen.**

Highlight the box beside **Alarm-Out** and press the  button. A list of Alarm Outputs appears. You can associate as many Alarm-Outs with the Text Input as you wish. When the DVR detects text input, it triggers output signals on all the associated Alarm-Out connectors. You can also have the DVR's internal buzzer sound if text input is detected.

**NOTE: For the Alarm-Out action, the alarm output and beep you select should be set to the Event mode in the Alarm-Out setup screen (Schedule tab).**

Highlight the box beside **Notify** and press the  button. You can toggle the entire list On and Off by highlighting **Notification** and pressing the  button. You can toggle the individual items On and Off by highlighting that item and pressing the  button. Highlight **OK** and press the  button to accept your changes.

**NOTE: For the Notify action, the notify item you select should be enabled in the Notification setup screen and the DVR should be registered in the RAS (Remote Administration System).**

Highlight the desired box under the **PTZ** heading, and press the  button. A list of PTZ presets appear. Select the preset positions for each PTZ camera, where you want PTZ cameras to move to when the DVR detects text input.

You can save your Text-In changes by highlighting **Save** and pressing the  button. Selecting **Cancel** exits the screen without saving the changes.

## System Event Screen

Highlight System Event in the Event menu and press the  button. The System Event setup screen appears.

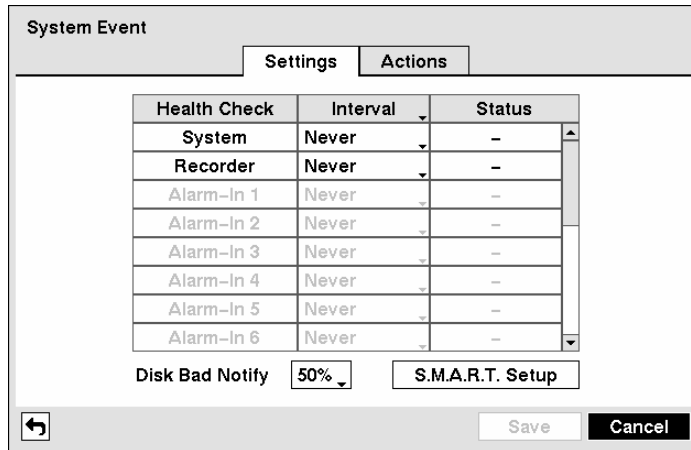

The screenshot shows the 'System Event' settings screen. It has two tabs: 'Settings' and 'Actions'. The 'Settings' tab is active. Below the tabs is a table with three columns: 'Health Check', 'Interval', and 'Status'. The table contains seven rows: 'System', 'Recorder', and six 'Alarm-In' entries (Alarm-In 1 through Alarm-In 6). All 'Interval' values are set to 'Never' and all 'Status' values are '-'. Below the table are two settings: 'Disk Bad Notify' set to '50%' and 'S.M.A.R.T. Setup'. At the bottom are three buttons: a left arrow, 'Save', and 'Cancel'.

Health Check	Interval	Status
System	Never	-
Recorder	Never	-
Alarm-In 1	Never	-
Alarm-In 2	Never	-
Alarm-In 3	Never	-
Alarm-In 4	Never	-
Alarm-In 5	Never	-
Alarm-In 6	Never	-

Disk Bad Notify: 50%      S.M.A.R.T. Setup



Buttons:  Save Cancel

Figure 84 — System Event Settings screen.

The DVR can be configured to run self-diagnostics and report the results.

Highlight the box under the Interval heading, and press the  button. A list of intervals ranging from 1 hr to 30 days or Never appears. You can select the interval that you want the DVR to run self-diagnostics on the system, recorder and Alarm Inputs.

If a time has been set in the Interval column, the Status column will display the status of the associated item.

Highlight the box beside Disk Bad Notify, and press the  button. Select percentage level of bad disk sectors at which you want the DVR to trigger an alert.

Highlight S.M.A.R.T. Setup, and press the  button. The S.M.A.R.T. Setup screen appears.

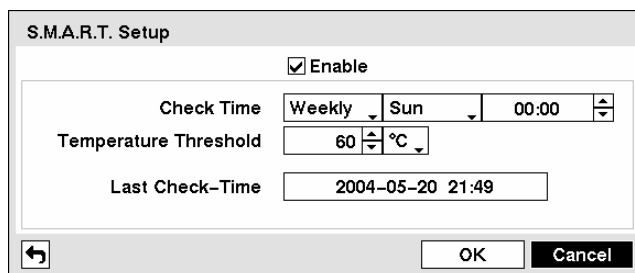

The screenshot shows the 'S.M.A.R.T. Setup' screen. It has a title bar 'S.M.A.R.T. Setup' and a checked 'Enable' checkbox. Below are three settings: 'Check Time' set to 'Weekly', 'Sun', and '00:00'; 'Temperature Threshold' set to '60 °C'; and 'Last Check-Time' set to '2004-05-20 21:49'. At the bottom are three buttons: a left arrow, 'OK', and 'Cancel'.

Enable

Check Time: Weekly Sun 00:00

Temperature Threshold: 60 °C

Last Check-Time: 2004-05-20 21:49





Buttons:  OK Cancel



Figure 85 — S.M.A.R.T. Setup screen.

Highlight Enable, and press the  button to toggle between On and Off.

**NOTE: If *Enable* is turned Off, you will not be able to make changes to any of the boxes.**

Highlight the box beside Check Time, and press the  button. You can select from Monthly, Weekly and Daily. If you select Monthly, you will be asked to set the Day of the Month and Time. If you select Weekly, you will be asked to set the Day of the Week and Time. If you select Daily, you will be asked to set the Time.

Highlight the first box beside Temperature Threshold, and press the  button. Use the Up and Down arrow buttons to scroll through the numbers. Refer to the hard disk drive manufacturer's documentation for the correct temperature setting. When the temperature of hard disk drive exceeds the defined threshold, the system triggers an alert.

Highlight the second box beside Temperature Threshold, and press the  button. Select either °C (Celsius) or °F (Fahrenheit), and press the  button.

The box beside Last Check-Time displays the Date and Time of the last S.M.A.R.T. check.

Highlight the OK, and press the  button to accept the changes. Selecting Cancel exits the screen without saving the changes.

Highlight the Actions tab and the System Event Actions screen displays.

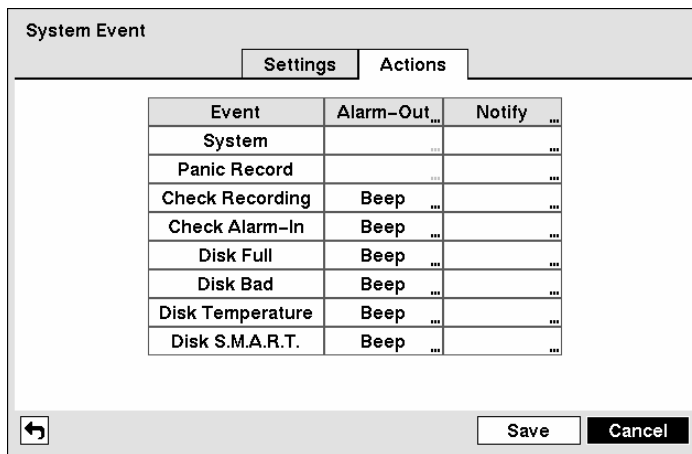

Figure 86 — System Event Actions screen.

The DVR can be set to react to system events. System events can be associated with an Alarm-Out connector, sound the DVR's internal buzzer, and/or notify a number of different devices.

Highlight the Alarm-Out box beside the desired event (Check Recording, Check Alarm-In, Disk Full, Disk Bad, Disk Temperature, or Disk S.M.A.R.T.), and press the  button. A list of Alarm Outputs appears. You can associate as many Alarm-Outs with the Event as you wish. If the DVR detects that event, it triggers output signals on all the associated Alarm-Out connectors. You can also have the DVR's internal buzzer sound if an event is detected.

**NOTE: Alarm-Out action cannot be set to System and Panic Record events.**

Highlight the Notify box beside the desired event (System, Panic Record, Check Recording, Check Alarm-In, Disk Full, Disk Bad, Disk Temperature, or Disk S.M.A.R.T.), and press the  button. You can toggle the entire list On and Off by highlighting Notification and pressing the  button. You can toggle the individual items On and Off by highlighting that item and pressing the  button. Highlight OK and press the  button to accept your changes.

**NOTE: Only Mail notify option is available for the System event.**

**NOTE: For the Notify action to work, the DVR should be registered in the RAS (Remote Administration System).**

You can save your System Event changes by highlighting Save and pressing the  button. Selecting Cancel exits the screen without saving the changes.

## Event Status Screen

Highlight Event Status in the Event menu and press the  button. The Event Status screen appears.

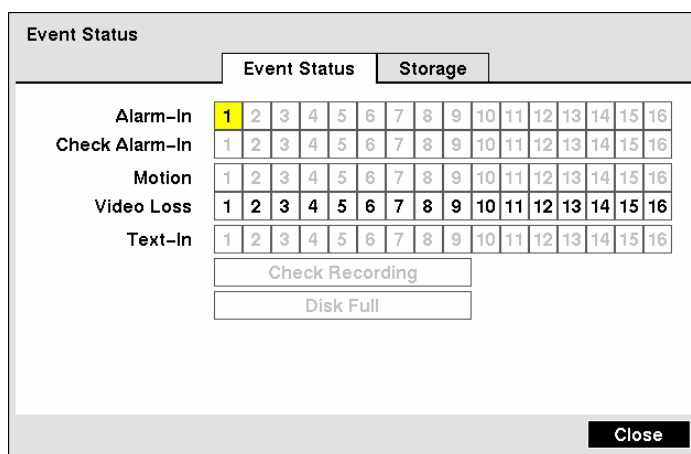

Figure 87 — Event Status screen.

The Event Status screen displays the status of the DVR's systems and inputs. Events will be highlighted, and related channels or events will be flickered for five seconds when detected.

**Alarm-In, Motion, Video Loss and Text-In** will be highlighted when each event is detected based on the settings you made in the Alarm-In, Motion Detection and Text-In setup screen on the Event menu.

**Check Alarm-In and Check Recording** will be highlighted when each event is detected based on the settings you made in the System Event setup screen in the Event menu.

**Disk Full** will be highlighted when the DVR is not in the Recycle mode and all available storage space has been used.

Highlighting the **Storage** tab will display the hard disk drive status. Refer to the **Storage Screen** section for details.



## Chapter 4 — Operation

**NOTE:** This chapter assumes your DVR has been installed and configured. If it has not, please refer to Chapters 2 and 3.

The DVR's controls are similar to a VCR. As with a VCR, the main functions are recording and playing back video. However, you have much greater control over recording and playing back video. You can establish recording schedules based on time of day and day of the week. The DVR allows you to search through the recorded video using much more sophisticated tools than those available with VCRs. Additional DVR features that are not available with VCRs are remote control and viewing, and recording video at the same time you are watching previously recorded video.

The front panel controls are described in *Chapter 3 — Configuration*.

### Turning on the Power

Once you have installed the DVR following the instructions in *Chapter 2 — Installation*, it is ready to record.

### Live Monitoring

As soon as the DVR completes its initialization process, it will begin showing live video on the attached monitor and playing live audio through the attached speaker. The default mode is to display all cameras at once. Pressing any camera button will cause that camera to display full screen. It displays live video and plays live audio until the user enters another mode.

Pressing the **DISPLAY** button cycles the DVR through the different display formats.

The DVR can be set to display full-screen video for a preset dwell time when an Event occurs. Video from the lowest camera number associated with the event sensor will be displayed, the DVR will return to the previous screen format after event monitoring dwell time expires. While the event monitoring is activated, the monitoring for all other subsequent events will be ignored. Pressing individual camera buttons or the **DISPLAY** button during event monitoring releases the current event monitoring and displays the selected camera or returns to the previous screen format.

Pressing the **SEQUENCE** button causes the cameras to display sequentially. When in one of the multi-view formats, pressing this button will cause the DVR to go through predefined screen layouts (Full Sequence). Or, the bottom, right screen will display live cameras sequentially (Cameo Sequence). Selecting another display mode, or pressing the **SEQUENCE** button again exits the Sequence mode. When in one of the multi-view formats, pressing the **Left** or **Right** arrow buttons will cause the DVR to go to the previous or the next page. For example, if you press the **Right** arrow button in the 4x4 format, the DVR changes pages as follows:

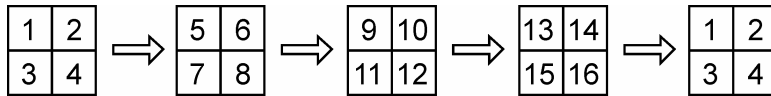



If all the cameras in a page are Off, have lost video or are set to Covert (unless the user has authority to view covert cameras), that page will be excluded from the sequence.

**NOTE: The Full Sequence for the full sequence monitoring and the Cameo Sequence for the cameo sequence monitoring should be selected in the Display setup screen (Sequence tab).**

Pressing the **FREEZE** button will freeze the current image on the screen until you press the button again. While in the Freeze mode, the icon  displays in bottom-left corner if Freeze is selected in the Display setup screen (OSD tab).

To display cameras sequentially on a spot monitor, press the **SPOT** button and select the Spot Monitor and Sequence from the menu.

### Active Cameo Mode

You can enter the Active Cameo mode by pressing the  button in any multi-view format. The yellow outline surrounding the video indicates the active cameo, and pressing the arrow buttons moves the active cameo. Pressing the  button while in the Active Cameo mode exits the Active Cameo mode. The active cameo mode will remain in effect for 15 seconds if there is no further operation.

In active cameo mode, press the button for the camera you want displayed as active cameo. After setting the camera number to active cameo, the DVR moves the active cameo to the next cameo. You can change the screen layout in this way.

### PIP Mode

You can display a Picture-in-Picture by pressing the **DISPLAY** button. You can change the location of the PIP counterclockwise and clockwise by pressing the **Up** and **Down** arrow buttons and change its size by turning the Jog Dial clockwise or counterclockwise.

## Zoom Mode

You can enlarge an area of the video by pressing the **ZOOM** button. For a few seconds after pressing the **ZOOM** button, a PIP displays. Inside the PIP, a rectangle shows the area that is enlarged. You can move the rectangle around using the arrow buttons. While in the Zoom mode, you can enlarge the area more by pressing the **+** button. The Zoom mode options are 2x, 3x and 4x. Exit the Zoom mode by pressing the **ZOOM** button. While in the Zoom mode, the icon **+** displays in bottom-left corner if Zoom is selected in the Display setup screen (OSD tab).

## PTZ Mode

If a user who has **PTZ Control** authority logs into the system, the user can control PTZ cameras. The DVR will control cameras with Pan, Tilt and Zoom capabilities. Press the **PTZ** button to enter the PTZ mode and press the button again to exit the PTZ mode. You can control the camera using front panel control buttons, by setting up presets or by selecting the expanded PTZ features.

Select the PTZ camera you wish to control by selecting it from the menu. The icon **PTZ** displays on the PTZ camera screen.

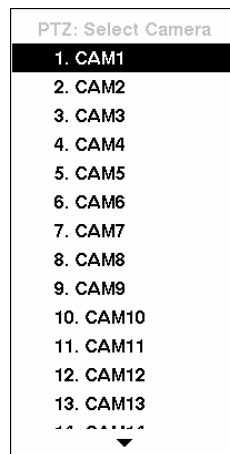

Figure 88 — PTZ Select Camera menu.

To use the front panel buttons, press the **Left** and **Right** arrow buttons to pan left and right. Press the **Up** and **Down** arrow buttons to tilt the camera up and down. Press the **+** button to zoom in, and press the **-** button to zoom out. You can use the **+** and **-** buttons to focus the image.

You can establish preset positions for PTZ cameras. Press the **P** to establish Presets.

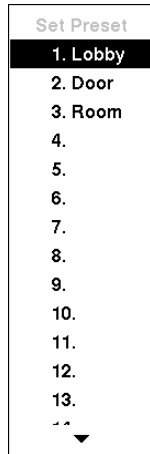



Figure 89 — PTZ Preset screen.

You can quickly move PTZ cameras to Preset positions. Press the  to view an establish camera Preset position.

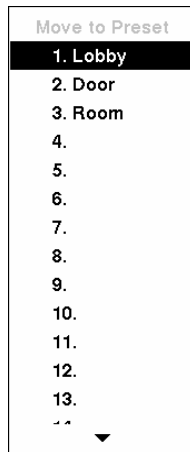





Figure 90 — Preset view screen.

You can save camera position settings as “presets” so that you can go directly to desired views. Once you have the camera at the desired settings, press the  button, and the PTZ Preset dialog box will appear. Select the number you want to assign to the preset and press the  button. Use the virtual keyboard to enter the preset name. Press the  button to load the PTZ preset and the Preset View dialog box will appear. Select the desired preset and press the  button to load the preset.

Pressing the **MENU** button displays the following PTZ menu. Set the feature you wish to control by selecting it from the menu. Refer to the camera manufacturer’s instructions for the proper settings. Depending on the camera specifications, some features may not be supported.



Figure 91 — PTZ menu.

You can use a mouse for convenient PTZ control. Position the mouse point at the bottom of the screen, and the following PTZ toolbar will display.

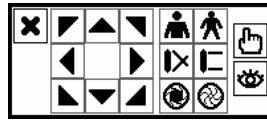

Figure 92 — PTZ controls

Clicking **X** on the left side exits the toolbar. If you want to display the toolbar again, position the mouse pointer at the bottom of the screen. Change the toolbar location by clicking the empty space on the left side of the toolbar and drag it to where you want it located on the screen. Use the arrow buttons on the toolbar to pan or tilt the camera to the direction you want, and other individual controls on the toolbar perform the following functions as described below:

	Zoom In / Out
	Focus Near / Far
	Iris Open / Close
	Set / Load Preset

## Image Adjustment

**NOTE:** It is important that cameras and monitors are correctly installed and adjusted prior to making any image adjustments using the DVR's controls.

If a user who has Color Control authority logs into the system, the user can adjust the image. Pressing and holding a camera button for a few seconds displays an image adjustment dialog. You can control brightness, contrast, hue and saturation for each camera.

**NOTE: Any image adjustments you make will be applied to both the live video on the monitors and the recorded video.**

## Event Monitoring

When an event occurs, the DVR will display the camera associated with the event if **Event Monitoring On** is selected in the Display setup screen (OSD tab).

How the cameras are displayed depends on the number of cameras associated with the event. If one camera is associated with the event, the DVR will display the camera full screen. If two to four cameras are associated with the event, the DVR will display the cameras on a 2x2 screen. If five to nine cameras are associated with the event, the DVR will display the cameras on a 3x3 screen. If 10 or more cameras are associated with the event, the DVR will display the cameras on a 4x4 screen.

Event monitoring lasts for the dwell time set for event recording. After the dwell time has elapsed, the monitor returns to the previous screen unless another event has occurred. If you want to return to the live monitoring mode before the dwell time has elapsed, press the **DISPLAY** button or one of the camera buttons.

## Covert Camera

If a camera is set up as **Covert 1** in the Camera setup screen (Settings tab), that camera will not be displayed unless a user with **Covert Camera View** authority logs into the system. However the camera title and status icons will be displayed on the monitor.

If a camera is set up as **Covert 2** in the Camera setup screen (Settings tab), that camera appears to be **Off** unless a user with **Covert Camera View** authority logs into the system. The camera title will be grayed out and status icons will not be displayed on the monitor.

**NOTE: When a camera is set up as Covert 1, the DVR displays the camera title and status icons on the covert video. When set up as Covert 2, the DVR displays only the camera title on the covert video.**

If a user who has **Covert Camera View** authority logs into the system, the user can view video from cameras set to **Covert 1** or **Covert 2** including the camera titles and status icons.

## Spot Monitoring

You can select the camera you want to display on a Spot Monitor. Press the **SPOT** button on the front panel or remote control, and select one of four Spot Monitors. Then, select the camera to be displayed on the Spot Monitor.

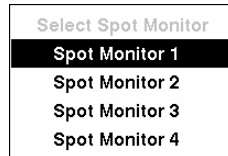

Figure 93 — Spot Monitor menu.

If you want to display more than one camera on a Spot Monitor, you can display them sequentially. In the Spot Monitor selection mode, press the **SEQUENCE** button on the front panel or remote control, or select **Sequence On** from the menu to start displaying cameras sequentially. Press the **SEQUENCE** button or select **Sequence On** again to stop sequencing on the Spot Monitor. Any cameras that are Off, have lost video or are set to **Covert** (unless the user has authority to view covert cameras) will be excluded from the sequence.

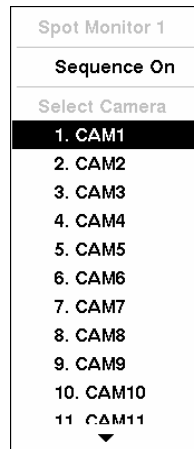

Figure 94 — Sequence menu.

When the Spot Monitor is in the sequence mode, you can set the camera's display dwell time. Refer to *Chapter 3 – Configuration – Display Screen* section for details.

**NOTE:** When the DVR is in the Search mode, it displays live video on the Spot monitor 1 as shown on the main monitor during the live mode if you set the Spot Monitor 1 to the Triplex Monitor (PRO Model only). Refer to *Chapter 3 – Configuration – Display Screen* section for details.

## Using a Mouse

You can use a mouse instead of the front panel buttons to perform many of the DVR functions. The following operations are supported when using a mouse during live monitoring.

When in one of the multi-view formats (e.g., PIP, 2x2, 3x3 or 4x4), clicking the mouse button on a camera image switches that camera to full screen. Clicking the mouse button again returns to the previous multi-view format.

When in one of the multi-view formats, scrolling the mouse wheel up and down operates the same as pressing the **DISPLAY** button by switching the screen format between PIP, 2x2, 3x3 and 4x4.

Clicking the right mouse button during live monitoring displays the following menu:

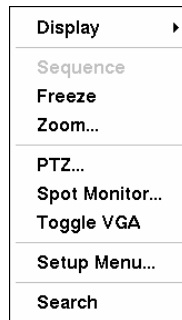

Figure 95 — Mouse menu.

Selecting Freeze, PTZ... and Spot Monitor... is the same as pressing the **FREEZE**, **PTZ** and **SPOT** buttons as described above in the *Live Monitoring* section of this chapter.

Selecting Zoom... zooms in on the live image. While in the zoom mode, there are two ways to move around the enlarged portion of the video. First, there is a PIP located in right-bottom corner. The PIP has a rectangle showing what area of the image has been enlarged. Click inside the PIP to move to another area of the image you want enlarged. Second, click and hold the mouse button on the enlarged video and drag the video.

Selecting Toggle VGA is the same as pressing and holding the **DISPLAY** button for more than five seconds. It switches the video out between Video Out (BNC or SVHS Out) and VGA Out. During clip copy, you cannot switch the video output between Video Out and VGA Out.

**CAUTION: The DVR will NOT record video for about 3 seconds while switching the video output between Video Out and VGA Out.**

Selecting Display shows the following menu:



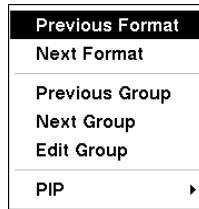

Figure 96 — Mouse Display menu.

Selecting **Previous Format** is the same as scrolling the mouse wheel up; switching from 4x4 to 3x3 to 2x2 to PIP. Selecting **Next Format** is the same as scrolling the mouse wheel down or pressing the **DISPLAY** button; switching from PIP to 2x2 to 3x3 to 4x4.

Clicking **Previous Group** or **Next Group** is the same as pressing the Left or Right buttons on the front panel which moves to previous or next page.

Selecting **Edit Group** supports the active cameo function. Select **Edit Group** and choose a camera that you want to change display position (e.g., Camera A). Then, click the right mouse button to display the menu. If you select another camera in the menu (e.g., Camera B), the screen displays Camera B instead of Camera A. When in the 4x4 format, Camera A and Camera B will switch positions.

Selecting **PIP** changes the location and the size of the PIP.

## Recording Video

Once you have installed the DVR following the instructions in *Chapter 2 — Installation*, it is ready to record. The DVR will start recording based on the settings you made in the **Record** setup screen. See *Chapter 3 — Configuration*.

**Recycle On or Recycle Off.** The factory default is **Recycle On**. It does this by recording over the oldest video once the hard disk is full. Setting the DVR to **Recycle Off** causes it to stop recording once the hard disk is full.

**Standard or High.** The factory default resolution is **Standard**. When set to **Standard**, the DVR has a maximum recording speed of 120 ips (240 ips for PRO model). When set to **High**, the DVR has a maximum recording speed of 60 ips (120 ips for PRO model).

**NOTE: When the DVR is in the search mode, the maximum recording speed decreases by half. For example, in the search mode, the DVR's maximum recording speed decreases to 60 ips (120 ips for Pro Model) when set to Standard resolution.**

Pressing the **PANIC** button starts panic recording of all cameras, and pressing the button again stop panic recording. If you set the Panic Recording Duration in the Record Screen, panic recording will be stopped automatically according to the preset duration as long as the **PANIC** button is not pressed.

**NOTE: When the DVR is not in the Recycle mode and all available storage space has been used, panic recording will not operate.**

Although you will be able to record without changing the unit from its original factory settings, you will want to take advantages of the DVR's many tools. See *Chapter 3 — Configuration* for detailed descriptions of the recording mode options.

## Recording Audio

If the DVR was set up to record audio, it will record audio from up to four inputs when video is recording. The DVR will not record audio when the recording speed is set to less than 1 ips.

**NOTE: Make certain you comply with all local and federal laws and regulations when recording audio.**

## Playing Recorded Video

If a user who has Search authority logs into the system, the user can view recorded image. Once video has been recorded, you can view it by pressing the **PLAY/PAUSE** button. When playing video for the first time, the DVR will display the most recent image. When playing video subsequent times, the DVR will start playing video from the last recalled image. Recorded audio will be played while the DVR displays the camera with recorded audio full screen.

**NOTE: While playing back video, the recording speed might decrease.**

**NOTE: Only the administrator and users with *Covert Camera View* authority can view video from covert cameras. The covert cameras in the playback mode are determined by the current camera setting.**

Pressing the **PLAY/PAUSE** button again will freeze the video on the screen.

### RW (Rewind) Button

Pressing the **RW** button plays video backward at high speed. Pressing the button again toggles the playback speed between **◀◀**, **◀◀◀** and **◀◀◀◀**. The screen displays **◀◀**, **◀◀◀** and **◀◀◀◀** respectively.

Entering Fast Backward Playback mode from Live Monitoring mode can be password protected.

## FF (Fast Forward) Button

Pressing the **FF** button plays video forward at high speed. Pressing the button again toggles the playback speed between **▶▶**, **▶▶▶** and **▶▶▶▶**. The screen displays **▶▶**, **▶▶▶** and **▶▶▶▶** respectively.

Entering Fast Playback mode from Live Monitoring mode can be password protected.

## BACKWARD Button

Pressing the **BACKWARD** button goes to the previous image.

## FORWARD Button

Pressing the **FORWARD** button goes to the next image.

## SEARCH/STOP Button

Pressing the **SEARCH/STOP** button while in the Playback mode returns the DVR to the Live Monitoring mode. Pressing the **SEARCH/STOP** button while in the Live Monitoring mode returns the DVR to the Search mode.

## Camera Buttons (1 to 16)

Pressing a camera button will display that camera full screen.

## DISPLAY Button

Pressing the **DISPLAY** button will cycle the display through the different screen layouts. The display modes are: full, 4x4, PIP, 3x3 and 2x2 (not all formats are available for the 9-channel DVR).

## ZOOM Button

Pressing the **ZOOM** button zooms the current play back image on the screen.

## Shuttle Ring

The Shuttle Ring only functions in the Playback mode. The Shuttle Ring is spring loaded and returns to the center position when released. Turning the ring clockwise plays video forward. Turning the ring counterclockwise plays video backward. Playback speed varies with the amount the ring is turned. The playback speeds are **◀◀**, **◀◀◀**, **◀◀◀◀**, **▶x0.5**, **▶**, **▶▶**, **▶▶▶** and **▶▶▶▶**.

When you release the ring, it snaps back to the center position and the video pauses.

## Jog Dial

The Jog Dial only functions when playback video has been paused. By turning the jog dial clockwise, you can play video forward image-by-image. By turning the jog dial counterclockwise, you play video backward image-by-image.







You can use a mouse for convenient playback control. Position the mouse pointer on the search screen, and the following search toolbar will display.



Figure 97 — Mouse Playback controls.

Clicking **X** on the left side exits the toolbar. If you want to display the toolbar again, position the mouse pointer on the screen. Change the toolbar location by clicking the empty space on the right side of the toolbar and drag it to where you want it located on the screen.

The individual controls on the toolbar perform the following functions as described below:

-  Go to the first image
-  Fast backward play
-  Go to the previous image
-  Play
-  Go to the next image
-  Fast forward play
-  Go to the last image

## Searching Video

Pressing the **MENU** button or clicking the right mouse button while in the Search mode displays the Search Menu.

**NOTE: While searching video, the recording speed might decrease.**

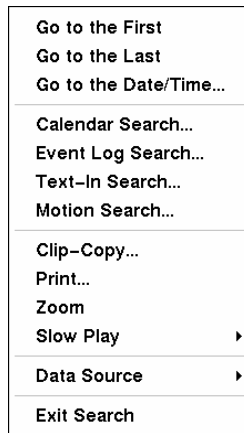

Figure 98 — Search menu.

- Go to the First — Displays the first recorded image
- Go to the Last — Displays the last recorded image
- Go to the Date/Time... — Searches by date and time (see below for more details)
- Calendar Search... — Searches using a calendar (see below for more details)
- Event Log Search... — Selects video from the event log (see below for more details)
- Text-In Search... — Searches text input strings (see below for more details)
- Motion Search... — Searches motion events (see below for more details)
- Clip-Copy... — Clips a video segment and saves it (see below for more details)
- Print... — Allows you to print a selected image (see below for more details)
- Zoom... — Zooms the current play back image
- Slow Play... — Plays video at low speed (x1/2, x1/3, x1/4, x1/6 and x1/8)
- Data Source — Allows you to choose between recorded and archived video
- Exit Search — Exits the Search Menu

**NOTE: The searching speed might decrease when all camera channels are in the pre-alarm recording mode.**

## Go to the Date/Time



Figure 99 — Go to the Date/Time screen.

Move the cursor over the date and time and press the **Enter** button. You can use the **Left** and **Right** arrow buttons to highlight the year, month, day, hours, minutes and seconds. Use the **Up** and **Down** arrow buttons to change to the date and time you want to search for video. Once you have set the date and time you want, press the **Enter** button. Then highlight **Go** and press the **Enter** button.

The selected date and time will display. (If no video was recorded at the selected time, a message appears alerting you that no image was recorded at that time.) The **PLAY/PAUSE**, **RW**, **FF**, **Jog** and **Shuttle** can now be used to review the surrounding video.

## Calendar Search

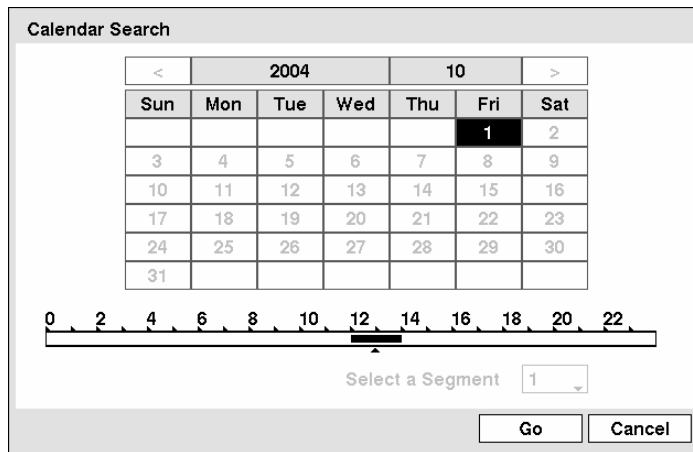

Figure 100 — Calendar Search screen.

Days with recorded video display on the calendar with white numbers. You can highlight the days with recorded video by using the arrow buttons. Once you have highlighted a day, press the **Enter** button to select it.

A time bar displays at the bottom of the calendar. Hours in which video was recorded will be highlighted with blue. You can use the **Up** and **Down** arrow buttons to highlight the time bar. Once the time bar is highlighted, you can select the time by using the **Left** and **Right** arrow buttons.

**NOTE: The time bar is in one-hour segments. If a segment is highlighted, it means that some video was recorded during that hour. However, it does NOT mean video was recorded for the entire hour.**

If the DVR's time and date have been reset to a time that is earlier than some recorded video, it is possible for the DVR to have more than one video stream in the same time range. Move to **Select a Segment**, and select the video stream you want to search.



**NOTE: The lower number of Segment indicates the latest recorded video.**

Once you have set the date and time you want to search, highlight **GO** and press the  button. The selected date and time will display. The **PLAY/PAUSE**, **RW**, **FF**, **Jog** and **Shuttle** can now be used to review the surrounding video.

**NOTE: It is possible that no recorded image displays on the current screen. Press the **DISPLAY** button and change the screen mode to 4x4. You can find recorded video during target hour easily.**

## Event Log Search

Event Log Search		
Time	Type	Title
2004-07-24 14:02:45	Video Loss 7	
2004-07-24 14:02:44	Video Loss 2	
2004-07-24 14:02:41	Alarm-In 3	
2004-07-24 14:02:20	Motion 16	
2004-07-24 14:02:19	Motion 3	
2004-07-24 14:02:18	Motion 11	
2004-07-24 14:02:18	Motion 6	
2004-07-24 14:02:07	Video Loss 9	
2004-07-24 14:02:05	Video Loss 7	
2004-07-24 14:01:52	Alarm-In 3	



Option...  

Close

Figure 101 — Event Log Search screen.

The DVR maintains a log of each time the Alarm Input port is activated. The **Event Log Search** screen displays this list. Use the arrow buttons to highlight the event for which you would like to see video.

The **Event Log Search** screen can also be accessed by pressing the **ALARM** button unless there is an alarm. There is no determined user authority to display the **Event Log Search** screen, however, the event video will not be played unless a user with **Search** authority logs into the system.

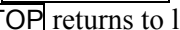
Pressing the  button will extract the event video and display the first image of the event. Pressing the  button will start playing the “event” video segment. Pressing  returns to live monitoring.

**NOTE: It is possible that no recorded image displays on the current screen. Press the  button and change the screen mode to 4x4. You can then easily find recorded video during target hour.**

You can also narrow your event search by selecting the Option... button and setting up the new search condition.

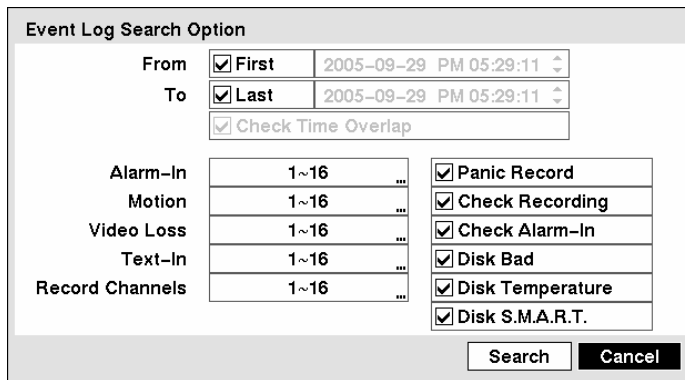





Figure 102 — Event Log Search Option screen.

You can search video from the first to last recorded images, or you can set the start and stop times and dates.

Highlight the box beside **From** and press the  button to toggle between On and Off. When set to Off, you can enter a specific Date and Time. When set to On, the search will be from the first recorded image.

Highlight the box beside **To** and press the  button to toggle between On and Off. When set to Off, you can enter a specific Date and Time. When set to On, the search will be from the last recorded image.

Highlight the box beside **Check Time Overlap** and press the  button. It toggles between On and Off. You will only be able to turn the Check Time Overlap on or off if a user-defined date and time is set to From and To. If the DVR’s date and time have been reset, it is possible for the DVR to have more than one overlapping start and stop time. When set to On, you will be asked to select one of overlapping start and stop time. When set to Off, the DVR will display search results from all start times to all stop times.

If the DVR’s time and date have been reset to a time that is earlier than some recorded video, it is possible for the DVR to have more than one video stream in the same time range. Move to **Select a Segment**, and select the video stream you want to search.



**NOTE: The lower the number, the more current recorded video is.**

Highlight the box beside **Alarm-In** and press the  button. You can select the alarm inputs that you want to include in your search.

Highlight the box beside **Motion** and press the  button. You can select the cameras for which you want any reports of motion detection.

Highlight the box beside **Video Loss** and press the  button. You can select the cameras for which you want any reports of lost video.

Highlight the box beside **Text-In** and press the  button. You can select the text-in devices which you want any report of text input.

Highlight the box beside **Record Channels** and press the  button. You can select the cameras that you want to search for any reports of event recorded data. The DVR will display the events (not the camera channels) that occurred and that also are recorded on the camera channel that you selected. If you do not select any camera channel in this field, the DVR will search events that are not associated with cameras.

You can also toggle On and Off self-diagnostic events as part of your search. The choices are:

- Panic Record
- Check Recording
- Check Alarm-In
- Disk Bad
- Disk Temperature
- Disk S.M.A.R.T.

Once you set your desired search conditions, highlight **Search** and press the  button to display the search results in the **Event Log** screen. Selecting **Cancel** exits the screen without saving the changes.

## Text-In Search

Text-In Search	
Time	Transaction
2004-07-24 14:06:23	Thank you~~
2004-07-24 14:06:22	7 Up   \$ 1.80
2004-07-24 14:06:22	Coke   \$ 2.20
2004-07-24 14:06:21	Item Unit price
2004-07-24 14:06:21	abc Market 2003.
2004-07-24 14:06:20	Thank you~~
2004-07-24 14:06:19	7 Up   \$ 1.80
2004-07-24 14:06:18	Coke   \$ 2.20
2004-07-24 14:06:18	Item Unit price
2004-07-24 14:06:18	abc Market 2003.

Option... ▲ ▼

Close

Figure 103 — Text-In Search screen.

The DVR maintains a log of each time there is Text Input. The **Text-In Search** screen displays this list. Use the arrow buttons to highlight the event for which you would like to see video.

Pressing the **←** button will extract the video associated with the Text Input and display the first image of the event. Pressing the **PLAY/PAUSE** button will start playing the “event” video segment. Pressing **SEARCH/STOP** returns to live monitoring.

**NOTE: It is possible that no recorded image displays on the current screen. Press the **DISPLAY** button and change the screen mode to 4x4. You can then easily find recorded video during target hour.**

**NOTE: Text Input information will be overlaid on the image while the recorded video is played at regular speed.**

You can also narrow your event search by selecting the **Option...** button and setting up the new search condition.

No.	Keyword
<input checked="" type="checkbox"/> 1	-
<input checked="" type="checkbox"/> 2	-
<input checked="" type="checkbox"/> 3	-
<input checked="" type="checkbox"/> 4	-
<input checked="" type="checkbox"/> 5	-

Figure 104 — Text-In Search Option screen.

You can search video from the first to last recorded images, or you can set the start and stop times and dates.

Highlight the box beside **From** and press the  button to toggle between On and Off. When set to Off, you can enter a specific Date and Time. When set to On, the search will be from the first recorded image.

Highlight the box beside **To** and press the  button to toggle between On and Off. When set to Off, you can enter a specific Date and Time. When set to On, the search will be from the last recorded image.

Highlight the **Channel** and press the  button. Select the text-in devices that you want to search for text input.

Highlight the **Text Input Device** box and press the  button. Select your Text Input Device from the list.

**NOTE: The following description is for a *Generic Text Device*. The screen changes for different types of text input devices, and there will be different parameter boxes for you to enter information.**

You can search for up to five text strings at a time. Highlight the number box and press the  button, and this will allow you to enter a keyword for that number.

Highlight the **Keyword** box and press the  button. You can enter a word or text string that you want to search for. If you do not enter any Keyword, a list of all Text Input events will be displayed.

Highlight **Case Sensitive** and press the  button. This will toggle between On and Off. When this feature is On, the search will find only those text strings in which the case matches.

Once you set your desired search conditions, highlight **Search** and press the  button to display the search results in the Event Log screen. Selecting **Cancel** exits the screen without saving the changes.

## Motion Search

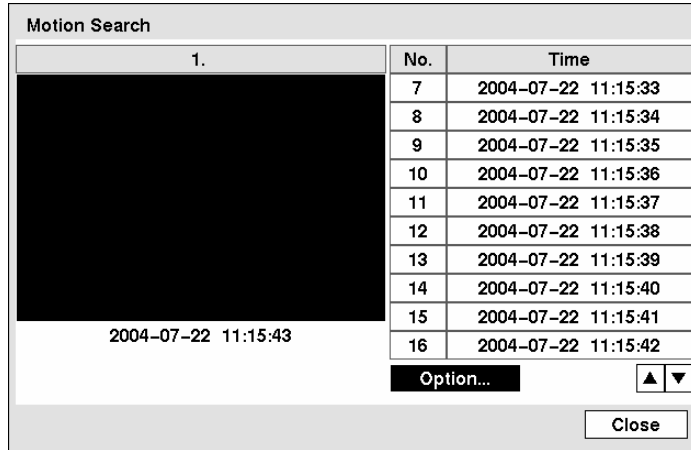



Figure 105 — Motion Search screen.

The **Motion Search...** can be selected from the Search menu while the DVR displays the camera full screen. The **Motion Search** screen displays a list of motion events. Use the arrow buttons to highlight the event for which you would like to see video.

Pressing the  button will extract the video associated with the Motion event and display the first image of the event. Pressing the **PLAY/PAUSE** button will start playing the “event” video segment. Pressing **SEARCH/STOP** returns to live monitoring.

You can also narrow your event search by selecting the **Option...** button and setting up the new search condition.

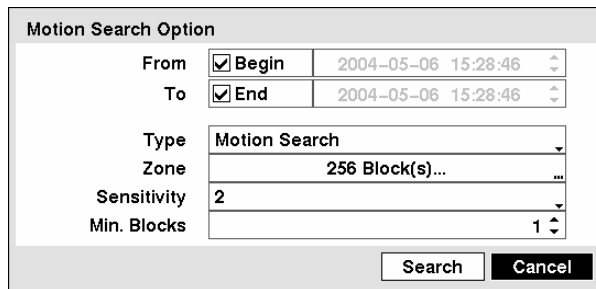

Figure 106 — Motion Search Option screen.

You can search video from the first to last recorded images, or you can set the start and stop times and dates.

Highlight the box beside **From** and press the  button to toggle between On and Off. When set to Off, you can enter a specific Date and Time. When set to On, the search will be from the first recorded image.

Highlight the box beside **To** and press the  button to toggle between On and Off. When set to Off, you can enter a specific Date and Time. When set to On, the search will be from the last recorded image.

Highlight the box beside **Type** and press the  button. You can select between **Motion Search** and **Museum Search**. **Motion Search** detects motion in the defined area. **Museum Search** detects if a defined object has moved.

Highlight the box beside **Zone** and press the  button. An image from the video appears with a grid overlaid. You can turn sensor blocks On and Off to define the area of the picture in which you want to search for motion.

**NOTE: Defining the area of the image in which you want to search for motion is nearly identical to setting up the DVR for Motion Detection. Please refer to *Motion Detection Screen* in *Chapter 3 — Configuration* for more detailed instructions on setting up the detection blocks.**

**NOTE: When setting the Museum Search Zone, the zone should be placed inside of the border line of the target object. If the selected block is placed on the boarder line, the sensitivity of the Museum Search may decrease.**

The zone should be placed or focused on the centre or, at least, within the outline of targeted object.

Highlight the box beside **Sensitivity** and press the  button. You will be able to select from 1 (low sensitivity) to 5 (high sensitivity).

Highlight the box beside **Min. Blocks** and press the  button. You will be able to set the number of sensor blocks that must be activated. Setting the Min Blocks will only be available if Motion Search is selected.

Once you set your desired search conditions, highlight **Search** and press the  button to display the search results in the **Event Log** screen. Selecting **Cancel** exits the screen without saving the changes.

When you search for motion events of another camera, you will be asked whether or not you want to delete the previous search results from the list.

## Clip-Copy Screen

The Clip-Copy screen can be used to copy video clips to an internal CD-RW drive or DVD RW, or external USB hard disk drive, CD-RW drive or flash drive. The copied video clips can be viewed on computers running Microsoft Windows 98, ME, 2000 or XP. Refer to the *Appendix A — USB Hard Disk Drive Preparation* for information on preparing the external drive for clip copy. The clip copy can be simply done by pressing the **MENU** button or the **FREEZE** button.

Press and hold the **MENU** button for more than two seconds while in the Search mode, and the Clip-Copy screen appears to allow clip copy setup.

Pressing the **FREEZE** button during the playback will set the starting point of video to be clip copied, and the icon  displays at the bottom-left corner of the screen. And press the **FREEZE** button again will set the ending point of video to be clip copied by displaying the Clip-Copy screen.

Pressing and holding the **FREEZE** button for more than two seconds while in the Search mode or Live Monitoring mode initiates the One-Touch Clip Copy function. The last recorded image will be the ending point of video to be clip copied, and the system will automatically begin to calculate the possible video data size that the selected storage media can handle.

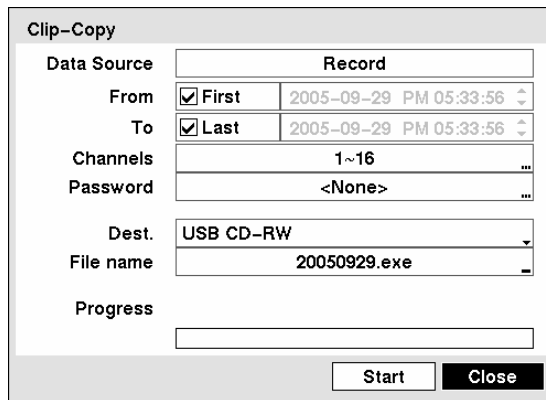



Clip-Copy	
Data Source	Record
From	<input checked="" type="checkbox"/> First 2005-09-29 PM 05:33:56
To	<input checked="" type="checkbox"/> Last 2005-09-29 PM 05:33:56
Channels	1~16
Password	<None>
Dest.	USB CD-RW
File name	20050929.exe
Progress	
<input type="button" value="Start"/> <input type="button" value="Close"/>	

Figure 107 — Clip-Copy screen.

The **Data Source** box displays the source from which you make a video clip copy. The data source can be selected from **Record** or **Archive** in the Search menu.

You can search video from the first to last recorded images, or you can set the start and stop times and dates.

Highlight the box beside **From** and press the  button to toggle between On and Off. When set to Off, you can enter a specific Date and Time. When set to On, the search will be from the first recorded image.

Highlight the box beside **To** and press the  button to toggle between On and Off. When set to Off, you can enter a specific Date and Time. When set to On, the search will be from the last recorded image.

Highlight the box beside **Channels** and press the  button. You can select the cameras that you would like to include in your video clip.

Highlight the box beside **Password** and press the  button. A virtual keyboard appears allowing you to enter the password for reviewing the video clips.

Highlight the box beside **Dest.** and press the  button. You can select the storage device on which you would like to record the video clip. You can choose from Internal CD-RW, Internal DVD RW, USB Storage and USB CD-RW.

**CAUTION: The USB device for clip copy must be FAT 16 or FAT32 format.**



**NOTE: While copying video clips on the CD-RW or DVD RW, the recording speed might decrease.**

**NOTE: While copying video clips on the CD-RW or DVD RW, the DVR will stop archiving video data until clip copy is finished.**

**NOTE: When the error message “Firmware update of the optical drive is required” displays, update the firmware of the installed CD-RW drive or DVD RW drive. Please follow the instructions described in *Chapter 3 – Configuration – System Information* section.**

The DVR automatically assigns a file name to the video clip. However, you can give the video clip file a different name. Highlight the box beside **File Name** and press the  button. A virtual keyboard appears. Enter a file name for the video you are backing up and select **Close**. The DVR will automatically add the camera number (for example “01”) and “.exe” to the file name. If you want to save the file in a specific folder, enter the folder name followed by a “/”. For example: “folder/filename”

**NOTE: When naming a file, you cannot use the following characters: \, /, :, \*, ?, “, <, >, |**

Once you have given the video clip a file name, highlight the **Start** button and press the  button. The confirmation screen displaying data size will appear. When the storage device does not have enough space, the DVR will ask if you want to copy as much of the video clip as possible in the available space. Highlight the **Continue** button and press the  button to continue clip copy.

Once the clip copy starts, you can cancel it by selecting **Cancel** or hide the screen by selecting **Close**. When selecting **Close**, Clip Copy continues and a confirmation screen will display when complete.

**NOTE:** Only 4.7GB DVD media is available. To clip copy video on the DVD media using remaining space, the size of previously recorded data on the DVD media should be less than 4GB.

**NOTE:** The file size for clip copy is limited to 2GB.

You can use other functions on the DVR while video is being backed up. To do this, highlight the Close button and press the  button. You can return to the Clip-Copy screen at any time to check the progress.

Refer to *Appendix B — Reviewing Clip Files* for instructions on how to review video clips you have copied.

**NOTE:** During Clip Copy, you cannot shut the system down, clear data on the storage device, or format the storage device.

**CAUTION:** Do NOT disconnect the USB cable or the power from the external drive while copying video clips. If the external drive is shut down or the USB cable is disconnected while copying video clips, THE DVR SYSTEM MAY NOT WORK NORMALLY OR THE EXTERNAL DRIVE COULD BE DAMAGED, and you will get an error message the next time you try to copy video clips. You will need to power down the DVR and restart it to get rid of the error message. Once the file system of the USB-IDE hard disk drive has been corrupted, this error message cannot be dismissed. Even after restarting the DVR it may automatically restart while preparing to clip copy. You must recover the file system using the recovery program, or you must reformat the hard disk drive.

## Print Screen

You can print images from the screen. Connect a PostScript™ printer to one of the USB ports. A message appears asking you if you want to print the current image.

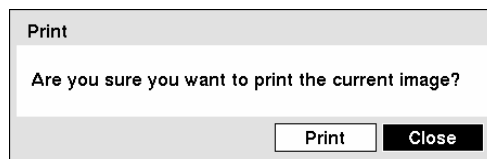

Figure 108 — Print screen.

**NOTE:** If your printer only supports an LPT connection (parallel), use a LPT to USB converter cable. The printer cable is not provided.



# Appendix A — USB Hard Disk Drive Preparation

## Preparing the USB-IDE hard disk drive in Windows 2000

**NOTE:** Preparing a USB-IDE hard disk drive under Windows XP is almost identical to Windows 2000.

1. Connect the USB-IDE hard disk drive to your computer using the USB Cable.
2. Turn on your computer.
3. The USB device icon should display on the Taskbar.
4. If the USB-IDE hard disk drive is partitioned or has data, it will show up in *My Computer* as a hard disk drive icon. Check the file system by right clicking on the icon and checking under *Properties > General > File System*. If the file system is NOT FAT32 format, format the USB-IDE hard disk drive using the FAT32 format.
5. If the USB-IDE hard disk drive is not partitioned, go to *Administrative Tools* in *Control Panel* and launch *Computer Management*. Open *Disk Management* in *Storage* and right click an unallocated region of the USB-IDE hard disk drive. Then, click *Create Partition*.
6. In the *Create Partition wizard*, click *Next* then *Primary Partition*, and follow the instructions on the screen. Make sure that the FAT32 is selected for the file system.

**NOTE:** The partition size should be less than 32GB because of Microsoft limitations.

After formatting is complete, the USB-IDE hard disk drive will be added to *My Computer*.

7. Connect the USB-IDE hard disk drive to the DVR.

## Preparing the USB-IDE hard disk drive in Windows 98

**NOTE: Preparing a USB-IDE hard disk drive under Windows ME is almost identical to Windows 98.**

1. Connect the USB-IDE hard disk drive to your computer using the USB Cable.
2. Turn on your computer. The *Add New Hardware wizard* window will appear.
3. Install the device driver for the USB backup device following the instructions provided with your USB hard disk drive.
4. If the USB-IDE hard disk drive is partitioned or contains data, it will show up in *My Computer* as a hard disk drive icon. Check the file system in *Properties > General > File System*. If the file system is NOT FAT32 format, format the USB-IDE hard disk drive with FAT32 format.
5. Run the FDISK utility by clicking *Start* then *RUN*. Type "fdisk" and click OK.
6. When the MS-DOS command prompt appears, type "Y" and hit the enter key.
7. In the FDISK Option menu, choose "5. Change current fixed disk drive."
8. Choose the appropriate letter corresponding to the USB-IDE hard disk drive.
9. In the FDISK Option menu, choose "1. Create DOS partition or Logical DOS Drive."
10. In the Create DOS Partition or Logical DOS Drive menu, choose "1. Create Primary DOS Partition." And Type "Y" to use all available space and hit the enter key. Hit ESC to exit the screen after the USB-IDE hard disk drive partition is created.
11. Restart your computer and verify the newly created drive is in *My Computer*.
12. Right click the newly created hard disk drive icon and select "Format".
13. In the Format Screen, select "Full" as the "Format type" and click "Start".
14. After formatting is complete, connect the USB-IDE hard disk drive to the DVR.

## Appendix B — Reviewing Video Clips

You do not need to install any special software on your personal computer to review the video clips. The copied video clip contains the ClipPlayer program.

If you used a USB device, disconnect either the external USB-IDE hard disk drive or USB flash drive from the DVR, and connect it to your PC. If you used a recordable CD, insert the CD in your computer's CD drive. Double-clicking the target clip file starts the ClipPlayer program.

**NOTE:** It is suggested that the computer used for the ClipPlayer program has at least a 800MHz Pentium III. If your CPU is slower than this, video clips recorded at maximum speed with very high image quality will be played back slowly. Also DirectX 8.0 or higher is required to install, and the VGA card with 16MB or higher video RAM is recommended for proper operation.





Figure 109 — ClipPlayer screen.

The ClipPlayer Screen displays the clip images.

**NOTE:** Proper image display depends on the display settings of your PC. If you are experiencing display problems, click the right mouse button on the background screen and select **Properties → Settings** then set the *Color quality* to “32 bit”. And then select **Advanced → Troubleshoot** then set the *Hardware Acceleration* to “Full”. Please make sure that DirectX version 8.0 or higher has been installed if the display problem continues to occur. To check the version of DirectX, click **Start → RUN** and type “dxdiag” then hit the enter key which will display DirectX Diagnostic Tool dialog box. And then move to the **Display** tab and make sure *DirectDraw Acceleration* is set to “Enabled” then test the DirectDraw by selecting the *DirectDraw Test* button. After changing the settings, update the driver version of the VGA card. If still have display problems after changing all display settings as described above, try to replace the video card. The video cards with an ATI chipset are recommended.

Clicking the X exits the Player program.

Click the  to go to the beginning of the video clip.

Click the  to play the video clip in fast reverse.

Click the  to go back one frame of the video clip.

Click the  to play the video clip.

Click the  to go forward one frame of the video clip.

Click the  to play the video clip in fast forward.

Click the  to go to the end of the video clip.

Click the  to show the previous page.

Click the  to cycle through the screen layouts. It cycles through 2x2, 3x3 and 4x4.

Click the  to show the next page.



Click the  to select from **Save**, **Print**, **Info**, **Image Processing** and **Video Format**. Selecting **Save** saves the current image in a bitmap file format to the local hard disk drive or floppy disk. Selecting **Print** lets you print the current image on the printer connected to your computer. Selecting **Info** displays Channel, Title, Time, Flag, Size and Resolution information about the image. Selecting **Image Processing** allows you to control brightness, blur and sharpen for play back images. Selecting **Video Format** allows you to find appropriate display environments that can be varied according to the types of graphic card installed in your PC. Use **Video Format** option when you are experiencing improper image display.

**NOTE:** *Image Processing* works only in the single-screen layout and also in the pause mode.

**NOTE: If you are not sure about the appropriate *Video Format* option, try each option until proper image display is being set.**

Click the  to select from Normal and Double screen views. Clicking the left mouse button on the enlarged image moves its position.

Click the  to display the image full screen.





Encryption icons display in bottom-right corner.  indicates the clip file has not been tampered with, and  indicates the system has detected tampering.

**NOTE: If the VGA card or monitor for your PC does not support 640x480 video resolution, *Full Screen* might not display properly when selected. If this happens, press the ESC key on your PC to return to the normal screen mode.**

Click the slider bar and move it left or right to move through the video clip.

Placing the mouse cursor on an image and clicking will cause that image to display full frame.

## Appendix C — Troubleshooting

Problem	Possible Solution
No Power	<ul style="list-style-type: none"> <li>• Check power cord connections.</li> <li>• Confirm that there is power at the outlet.</li> </ul>
No Live Video	<ul style="list-style-type: none"> <li>• Check camera video cable and connections.</li> <li>• Check monitor video cable and connections.</li> <li>• Confirm that the camera has power.</li> <li>• Check camera lens settings.</li> </ul>
Live Video Very Bright	<p>If a cable is attached to the “Loop” connector, make certain it is connected to a properly terminated device.</p>
DVR has stopped recording	<p>If hard disk drive is full, you will either need to delete video or set the DVR to the Overwrite Mode.</p>
<p>The icon  displays, however, the DVR is not recording.</p>	<p>When the DVR is in the Pre-Event recording mode, the yellow  and  display when there is no event, and the DVR is not recording. The red  and  display when any event occurs and the DVR starts recording.</p>

# Appendix D — Connector Pin Outs

## I/O Connector Pin Outs



AI (1 to 16)	Alarm Inputs 1 to 16
GND	Chassis Ground (9 connectors)
AO (1 to 16)	Alarm Outputs 1 to 16
ARI	Alarm Reset In

## RS485 Connector Pin Outs

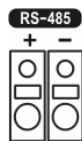

Master Unit	Slave Unit
+ → To	→ TX+
- → To	→ TX-
+ → To	→ RX+
- → To	→ RX-

## Appendix E — Map of Screens

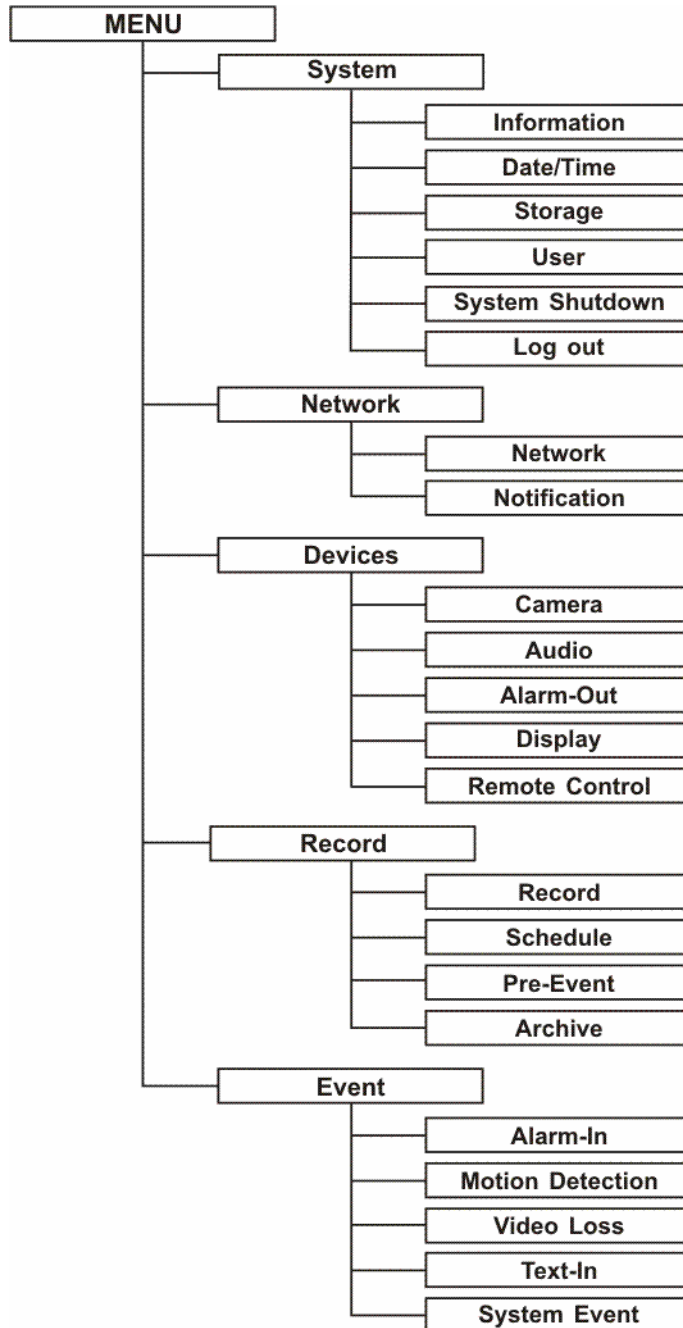



## Appendix F — System Log Notices

Boot Up
Shutdown
Restart
Upgrade
Upgrade Fail
Power Failure
Time Change
Time Zone Change
Time Sync
Time Sync Fail
Disk Bad
Login
Logout
Setup Begin
Setup End
Remote Setup Change
Remote Setup Fail
Setup Imported
Setup Import Failure
Setup Exported
Setup Export Failure
Setup Export Cancelled
Schedule On
Schedule Off
Panic On
Panic Off
Clear All Data
Clear Disk
Format Disk
Disk Full
Auto Deletion
Search Begin
Search End
Clip-Copy Begin
Clip-Copy End
Clip-Copy Cancel
Clip-Copy Fail
Callback Fail
Print Begin
Print End
Print Cancel

## Appendix G — Error Code Notices

System Upgrade Related	
Number	Description
0	Unknown error.
1	File version error.
2	Operating system version error.
3	Software version error.
4	Kernel version error.
100	Upgrade device mounting failed.
101	Package is not found.
102	Extracting package failed.
103	LILO failed.
104	Rebooting failed.
105	Invalid package.
106	Odd firmware upgrade failed.
300	Remote connection failed.
301	Remote network error.
302	Remote upgrade is not authorized.
303	Saving remote package failed.
304	Remote upgrade is cancelled by the user.
400	USB device mounting failed.
401	Reading upgrade package on the USB device failed.
402	Copying upgrade package on the USB device failed.
500	System is busy clip copying.

Clip Copy Related	
Number	Description
0	Unknown error.
1	Device error.
2	Mounting failed.
3	No media.
4	Invalid media.
5	File already existed.
6	Not enough space.
7	Creating temporary file failed.
8	Opening disk failed.
9	Formatting disk failed.
10	Database has been changed.
11	Appending failed.
12	Bad sector.
13	No executable file.
14	Opening executable file failed.
15	Writing executable file failed.
16	Creating image failed.
17	Burning failed.
18	Burning is out of time.

## Appendix H — Specifications

VIDEO	
Signal Format	NTSC or PAL (Auto Detect)
Video Input	Composite: 9 or 16 looping inputs, 1 Vp-p, auto-terminating, 75 Ohms
Monitor Outputs	Composite: 1 BNC, 1 Vp-p, 75 Ohms SVHS: 1 SPOT: 4 BNC, 1 Vp-p, 75 Ohms VGA: 1 - NTSC: 30.8kHz (horizontal frequency) / 60Hz (vertical frequency) - PAL: 30.8kHz (horizontal frequency) / 50Hz (vertical frequency)
Video Resolution	720x480 (NTSC), 720x576 (PAL)
Playback/Record Speed (images per second)	Standard Model: 120ips (NTSC), 100ips (PAL) Pro Model: 240ips (NTSC), 200ips (PAL)

INPUTS/OUTPUTS	
Alarm Input	9 or 16 TTL, programmable as NC or NO
Alarm Output	9 or 16 TTL open collector, 5mA@12V, 30mA@5V
Alarm Reset Input	1 TTL
Internal Buzzer	800dB at 10cm
Network Connectivity	10/100 Mbps Ethernet (RJ-45) RS-232C for external modem
Audio Input	RCA Input: 4 Line In
Audio Output	RCA Output: 1, Line Out
IR Port	1 Remote Control

CONNECTORS	
Video Input	Composite: 9 or 16 BNC
Video Loop	Composite: 9 or 16 BNC (Auto Terminating)
Monitor Output	Composite: 1 BNC SVHS: 1 Y/C* VGA: 1 VGA SPOT (Composite): 4 BNC
Audio In	4 RCA connector
Audio Out	1 RCA connector
Alarm Input/Output	16/16 Push-button, Terminal Blocks
Ethernet Port	RJ-45
RS232C Serial Port	DB9 (P)
RS485 Serial Port	Two-connector terminal block
UltraWide SCSI Port	High density female 68 pin connector
USB Port	3 (USB 2.0)

\* Using a shielded S-Video cable provides better quality video display and reduces image noise.

Specifications are subject to change without notice.

<b>STORAGE</b>	
Primary Storage	EIDE hard disk drive (up to 4) (up to 3 with an internal CD-RW drive or DVD RW)
Secondary Storage**	UltraWide SCSI hard disk drive (RAID) Built-in CD-RW drive USB hard disk drive, CD-RW drive or flash drive

\*\* When installing an internal CD-RW drive or DVD RW drive, set a jumper on Master and connect to the Secondary IDE channel.

<b>GENERAL</b>	
Dimensions (W x H x D)	16.9" x 3.5" x 15.9" (430mm x 88mm x 405mm)
Unit Weight	22.5 lbs. (10.2kg)
Shipping Weight	27.6 lbs. (12.5kg)
Shipping Dimensions (W x H x D)	21.3" x 11.4" x 23.2" (540mm x 290mm x 590mm)
Operating Temperature	41°F to 104°F (5°C to 40°C)
Operating Humidity	0% to 90%
Power	100 to 230 VAC, 2 A, 60/50Hz
Power Consumption	Max. 85W (100W when 4 hard disk drives are installed)
Approvals	FCC, UL, CB, CE

Specifications are subject to change without notice.

## **WEEE (Waste Electrical & Electronic Equipment)**

### ***Correct Disposal of This Product***

***(Applicable in the European Union and other European countries with separate collection systems)***

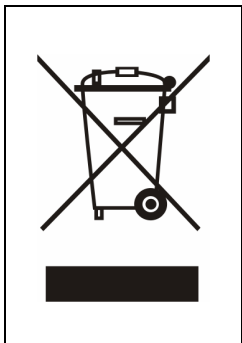

This marking shown on the product or its literature, indicates that it should not be disposed with other household wastes at the end of its working life. To prevent possible harm to the environment or human health from uncontrolled waste disposal, please separate this from other types of wastes and recycle it responsibly to promote the sustainable reuse of material resources.

Household users should contact either the retailer where they purchased this product, or their local government office, for details of where and how they can take this item for environmentally safe recycling.

Business users should contact their supplier and check the terms and conditions of the purchase contract. This product should not be mixed with other commercial wastes for disposal.