

# Full HD Multi-Streams Ultra-WDR Mini Dome IP Camera

## User's Manual

Ver. 1.7

# Table of Contents

|   |           |
|---|-----------|
| <b>1. Overview</b> .....                            | <b>2</b>  |
| 1.1 Features .....                                  | 2         |
| 1.2 Package Contents .....                          | 3         |
| 1.3 Dimensions.....                                 | 5         |
| 1.4 Connectors (Indoor Only).....                   | 6         |
| 1.5 Function Cables (Outdoor Only) .....            | 7         |
| <b>2. Camera Cabling</b> .....                      | <b>8</b>  |
| 2.1 Power Connection .....                          | 8         |
| 2.2 Ethernet Cable Connection.....                  | 8         |
| 2.3 Alarm I/O Connection .....                      | 9         |
| 2.4 Waterproof Cable Connector (Outdoor Only).....  | 9         |
| <b>3. System Requirements</b> .....                 | <b>11</b> |
| <b>4. Access Camera</b> .....                       | <b>12</b> |
| <b>5. Setup Video Resolution</b> .....              | <b>18</b> |
| <b>6. Configuration Files Export / Import</b> ..... | <b>19</b> |
| <b>7. Tech Support Information</b> .....            | <b>20</b> |
| 7.1 Delete the Existing DCViewer.....               | 20        |
| 7.2 Setup Internet Security .....                   | 21        |
| <b>Appendix: Technical Specifications</b>           |           |

# 1. Overview

The Full HD Multi-Streams Ultra-WDR Mini Dome IP Camera is an easy setup camera with PoE supported to reduce complicate cabling without sacrificing performance. Quad Streams Compression (H.264 Baseline / Main / High Profile + MJPEG) are supported for efficient bandwidth and storage management. The H.264 encoder performance is up to 1080P 60 fps. Also, the camera can supply Dual Full HD 1080P Real-time streaming. With more computing power, the camera could provide more flexibility for users and system managers. The camera also supports Shutter WDR function, which can provide high quality images under extreme light contrast or light changing scenarios.

## 1.1 Features







- Sony Progressive Scan CMOS Sensor
- 1.3M / 2M Resolution\*
- Quad Streams Support
- Dual Streams-Full HD 1080P Real-time + Full HD 1080P Real-time
- Quad Stream Compression- H.264 Baseline / Main / High Profile + MJPEG
- Multi-language Support
- Smart Event Function-  
Motion Detection / Network Failure Detection / Tampering Alarm / Periodical Event / Manual Trigger / Audio Detection
- Ultra Dynamic Range
- Privacy Masks
- 3D / 2D Noise Reduction
- Day/Night (ICR)
- IR LED Module (working distance up to 25 m)\*
- Digital Image Stabilizer (DIS)
- BNC Analog Output\*
- Weatherproof (IP66 International)\*
- microSD Support
- ONVIF Support

(\*) Optional

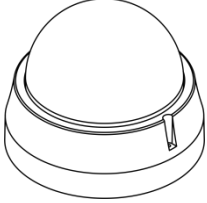
## 1.2 Package Contents

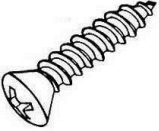
Please check the package contains the following items listed below.

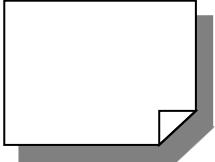
### Indoor

|  |  |
|--|--|
|  <p>Full HD Multi-Streams Ultra-WDR<br/>Mini Dome IP Camera</p> |  <p>3-Pin Power Terminal Block</p>                    |
|  <p>Self-Tapping Screw (x3)</p>                                 |  <p>Plastic Screw Anchor (x3)</p>                     |
|  <p>Quick Guide</p>   |  <p>CD<br/>(bundled software and documentation)</p> |









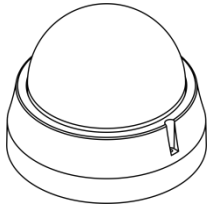
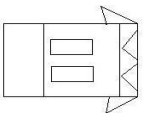

**NOTE:** Users **MUST** pre-drill and use plastic anchors before fastening the supplied self-tapping screws on the wall.

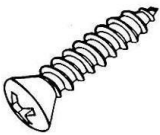

**NOTE:** To purchase power adaptor, please contact the camera manufacturer for further information.

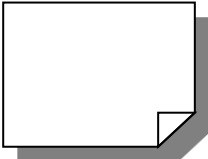
## Outdoor

|  |   |
|--|---|
| <br>Full HD Multi-Streams Ultra-WDR Mini Dome IP Camera |   |
| <br>2-Pin Power Terminal Block                          | <br>4-Pin Alarm I/O Terminal Block               |
| <br>Rubber Washer (x2)                                 | <br>Security Torx                               |
| <br>Self-Tapping Screw (x3)                           | <br>Plastic Screw Anchor (x3)                  |
| <br>Quick Guide                                       | <br>CD<br>(bundled software and documentation) |



**NOTE:** Users **MUST** pre-drill and use plastic anchors before fastening the supplied self-tapping screws on the wall.



**NOTE:** To purchase power adaptor, please contact the camera manufacturer for further information.

# 1.3 Dimensions

The dimensions of the camera are shown below.

## Indoor

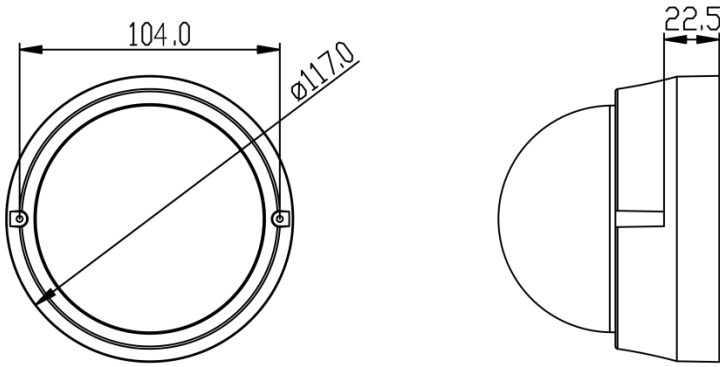
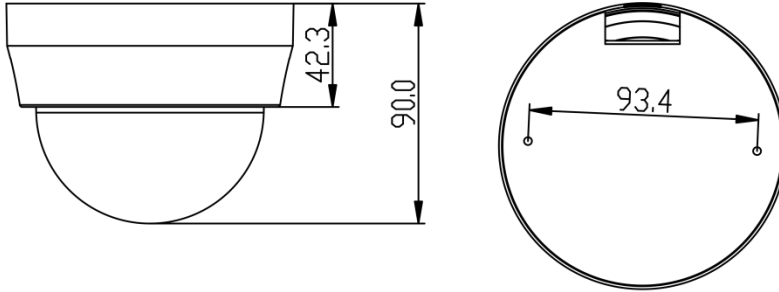

Unit: mm

## Outdoor

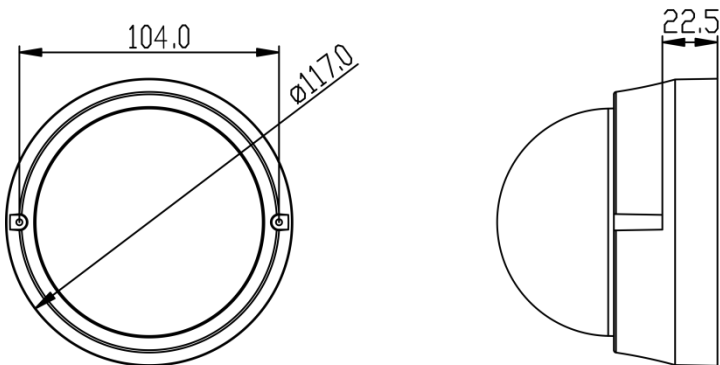
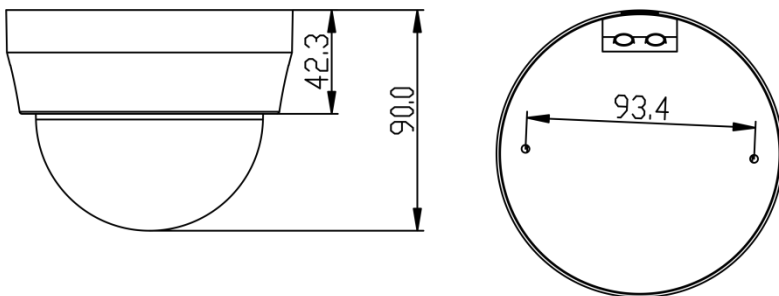

Unit: mm

## 1.4 Connectors (Indoor Only)

The diagram below shows the default button and various connectors of the camera. Definition for each connector is given as follows.

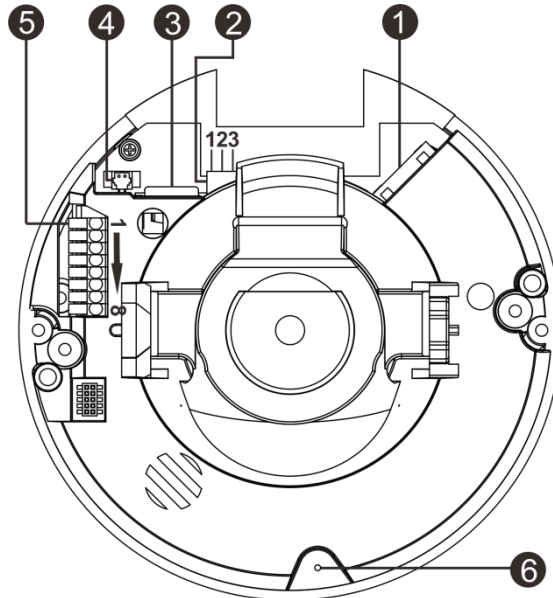

| No. | Connector                  | Pin | Definition  | Remarks          |                  |
|-----|----------------------------|-----|---|------------------|------------------|
| 1   | RJ-45                      | -   | For network and PoE connection  |                  |                  |
| 2   | Power<br>(DC 12V / AC 24V) | 1   | DC 12V  | AC 24V 1         | Power connection |
|     |                            | 2   | DC 12V Reserved   | AC 24V GND       |                  |
|     |                            | 3   | DC 12V GND  | AC 24V 2         |                  |
| 3   | microSD Card Slot          | -   | Insert the microSD card into the card slot to store videos and snapshots. Do not remove the microSD card when the camera is powered on. |                  |                  |
| 4   | BNC*                       | -   | For analog video output (installation purpose)  |                  |                  |
| 5   | Alarm & Audio I/O*         | 1   | Alarm In -  | Alarm connection |                  |
|     |                            | 2   | Alarm In +  |                  |                  |
|     |                            | 3   | Alarm Out -   |                  |                  |
|     |                            | 4   | Alarm Out +   |                  |                  |
|     |                            | 5   | Audio Out R   | Audio Out        |                  |
|     |                            | 6   | Audio Out L   |                  |                  |
|     |                            | 7   | GND   |                  |                  |
| 8   | Audio In                   |     |   |                  |                  |
| 6   | Default Button             | -   | Press the button with a proper tool for at least 20 seconds to restore the system.  |                  |                  |

(\*) Optional



**NOTE:** It is not recommended to record with the microSD card for 24/7 continuously, as it may not be able to support long term continuous data read/write. Please contact the manufacturer of the microSD card for information regarding reliability and life expectancy.

## 1.5 Function Cables (Outdoor Only)

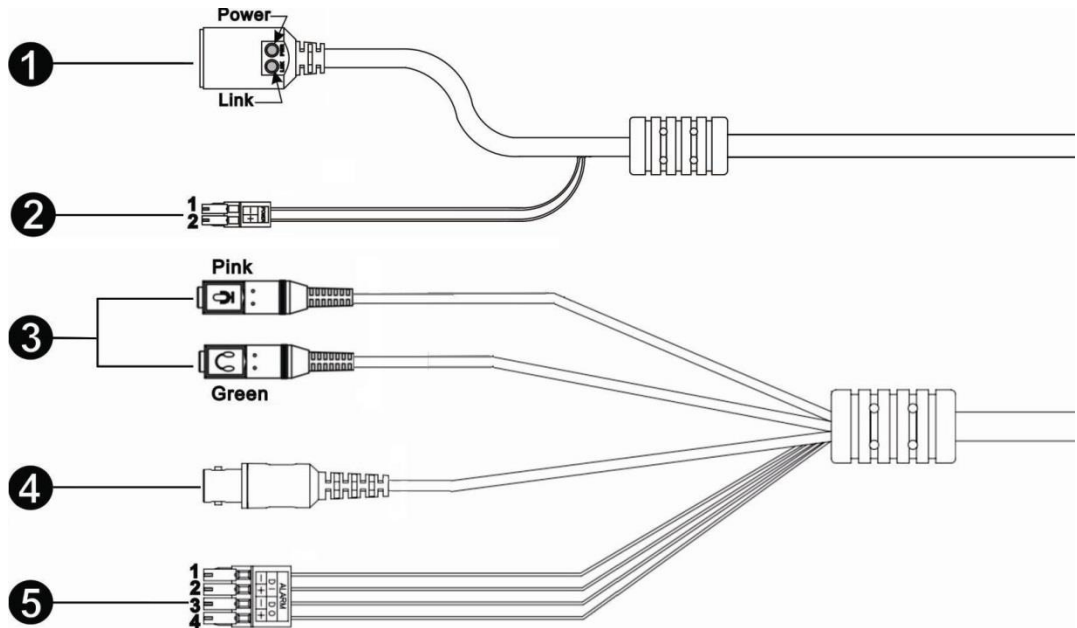

| No. | Connector                  | Pin   | Definition   | Remarks                    |
|-----|----------------------------|-------|--|----------------------------|
| 1   | RJ-45                      | -     | For network and PoE connection   |                            |
| 2   | Power<br>(DC 12V / AC 24V) | 1     | DC 12V 1 / AC 24V 1  | Power connection           |
|     |                            | 2     | DC 12V 2 / AC 24V 2  |                            |
| 3   | Audio I/O*                 | Pink  | Audio In   | Two-way audio transmission |
|     |                            | Green | Audio Out  |                            |
| 4   | BNC*                       | -     | For analog video output  |                            |
| 5   | Alarm I/O*                 | 1     | Alarm In -   |                            |
|     |                            | 2     | Alarm In +   |                            |
|     |                            | 3     | Alarm Out -  |                            |
|     |                            | 4     | Alarm Out +  |                            |
| -   | Default Button             | -     | For the position of the default button, please refer to the diagram shown in section <a href="#">Connectors (Indoor Only)</a> .    |                            |
| -   | microSD Card Slot          | -     | For the position of the microSD card slot, please refer to the diagram shown in section <a href="#">Connectors (Indoor Only)</a> . |                            |

(\*) Optional



## 2. Camera Cabling

Before users connect cables, make sure that all cables and the power adaptor are placed in dry and well-waterproofed environments, e.g. waterproof boxes. The purpose is to prevent moisture accumulation inside the camera and moisture penetration into cables, which might lead to camera breakdown. Please refer to the following sections for camera connection.

### 2.1 Power Connection

For power connection, please refer to section [Connectors \(Indoor Only\)](#) for indoor models, and see section [Function Cables \(Outdoor Only\)](#) for outdoor models. Alternatively, users can power the camera by PoE if a Power Sourcing Equipment (PSE) switch is available. Please refer to the section below for Ethernet cable connection.



**NOTE:** If PoE is used, make sure PSE is in use in the network.

### 2.2 Ethernet Cable Connection

For best transmission quality, cable length shall not exceed 100 meters. Connect one end of the Ethernet cable to the RJ-45 connector of the camera / function cable, and plug the other end of the cable to the network switch or PC.



**NOTE:** In some cases, Ethernet crossover cable might be needed when connecting the IP camera directly to the PC.

Check the status of the link indicator and the activity indicator LEDs. If the LEDs are unlit, please check the LAN connection.

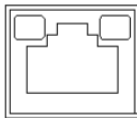

Green Link Light indicates good network connection.

Orange Activity Light flashes for network activity indication.

## 2.3 Alarm I/O Connection

For indoor models, connect alarm devices to the first 4 pins of the camera's 8-pin terminal block. For outdoor models, connect alarm devices to the 4-pin terminal block of the All-in-One cable. Refer to sections [Connectors \(Indoor Only\)](#) and [Function Cables \(Outdoor Only\)](#) for the pin definitions.



**NOTE:** Do **NOT** connect external power supply to the alarm I/O connector of the IP camera.

## 2.4 Waterproof Cable Connector (Outdoor Only)

Follow the instruction below to waterproof the connectors of different types of cables. The supported cables are as shown below.

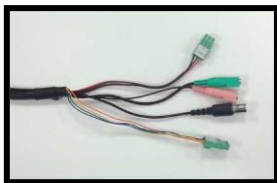

**All-in-One Cable**



**RJ-45 Cable**



**IP66 RJ-45 Cable**

### All-in-One Cable

Follow the steps below to waterproof the connectors of the All-in-One cable.

#### **Step 1:**

Plug the cables to the connectors of the All-in-One cable and coat the joints with silicone gel. There should be no gap between the connectors and the cables. For alarm I/O connector and power connector, make sure the side with wires attached is also sealed with silicone gel.

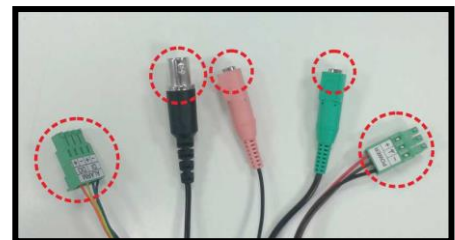

#### **Step 2:**

Seal the end of the rubber coating of the All-in-One cable as indicated in the figure on the right. Please use enough silicone gel to fill in the hose and wrap around each wire; otherwise, waterproof function cannot be guaranteed.

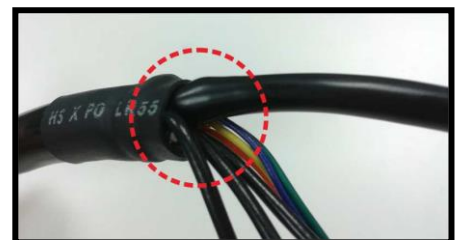

### **RJ-45 Cable**

Follow the instruction below to waterproof the connector of the RJ-45 cable.

Plug the Ethernet cable to the connector of the RJ-45 cable and coat the joint with silicone gel. Make sure there is no gap between the Ethernet cable and the connector; otherwise, waterproof function cannot be guaranteed.



### **IP66 RJ-45 Cable**

For IP66 RJ-45 cable, please use an RJ-45 IP66 plug for connection to prevent water damage. Follow the steps below for cable connection.

#### **Step 1:**

Take out the supplied connector from the RJ-45 IP66 plug. Loosen the thread-lock sealing nut on the plug. Then thread the Ethernet cable through the thread-lock sealing nut and the plug. If the Ethernet cable is already attached to a connector, please remove it first.

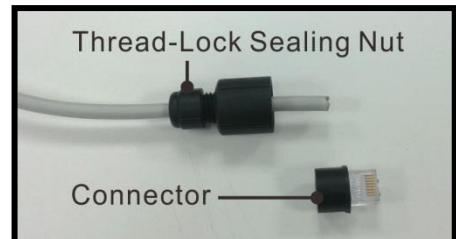

#### **Step 2:**

Carefully remove a section of rubber coating from the end of the Ethernet cable to reveal the wires. Inset the wires to the correct pins of the connector. Plug the Ethernet cable to the connector of IP66 RJ-45 cable.



#### **Step 3:**

Fasten the RJ-45 IP66 plug to the connector of the IP66 RJ-45 cable. Lastly, tighten the thread-lock sealing nut to the plug.



### 3. System Requirements

To perform the IP camera via web browser, please ensure the PC is in good network connection, and meet system requirements as described below.

| Items                    | System Requirement  |
|--------------------------|---|
| <b>Personal Computer</b> | 1. Intel® Pentium® M, 2.16 GHz or<br>Intel® Core™2 Duo, 2.0 GHz<br>2. 2 GB RAM or more  |
| <b>Operating System</b>  | Windows VISTA / Windows XP / Windows 7  |
| <b>Web Browser</b>       | Microsoft Internet Explorer 6.0 or later (Recommended)<br>Firefox (32-bit)<br>Safari    |
| <b>Network Card</b>      | 10Base-T (10 Mbps), 100Base-TX (100 Mbps) or<br>1000Base-T (1000 Mbps) operation        |
| <b>Viewer</b>            | ActiveX control plug-in for Microsoft IE<br>Apple QuickTime 7.7.7 or before for Firefox |



**NOTE:** The ITE is to be connected only to PoE networks without routing to the outside plant or equivalent description.

## 4. Access Camera

For initial access to the IP camera, users can search the camera through the installer program: DeviceSearch.exe, which can be found in “DeviceSearch” folder in the supplied CD.

### **Accessing the Camera by Device Search Software**

**Step 1:** Double click on the program Device Search.exe.

**Step 2:** After its window appears, click on the <Device Search> button on the top. All the finding IP devices will be listed in the page.

**Step 3:** Find the camera in the list by its IP address and click on it. The default IP address of the camera is: 192.168.0.250.

**Step 4:** The default IP address of the camera may not be in the same LAN as the IP address of the PC. If so, the IP address of the camera needs to be changed. Right click on the camera and click <Network Setup>. Meanwhile, record the MAC address of the camera, for future identification.

**Step 5:** The <Network Setup> page will come out. Select <DHCP> and click <Apply> down the page. The camera will be assigned with a new IP address.

**Step 6:** Click <OK> on the Note of setting change. Wait for one minute to re-search the camera.

**Step 7:** Click on the <Device Search> button to re-search all the devices. Find the camera in the list by its MAC address. Then double click or right click and select <Browse> to access the camera directly via a web browser.

**Step 8:** A prompt window requesting for default username and password will appear. Enter the default username and password shown below to login to the camera.

| Login ID | Password |
|----------|----------|
| Admin    | 1234     |



**NOTE:** ID and password are case sensitive.



**NOTE:** It is strongly advised that administrator's password be altered for the security concerns. Refer to the [Full HD Multi-Streams Ultra-WDR IP Camera Menu Tree](#) in the supplied CD for further details.

### **Installing DCViewer Software Online**

For initial access to the IP camera, a client program, DCViewer, will be automatically installed to the PC when connecting to the camera.

If the web browser doesn't allow DCViewer installation, please check the Internet security settings or ActiveX controls and plug-ins settings (refer to section [Setup Internet Security](#)) to continue the process.

The Information Bar (just below the URL bar) may come out and ask for permission to install the ActiveX Control for displaying video in browser. Right click on the Information Bar and select <Install ActiveX Control...> to allow the installation.

The download procedure of DCViewer software is specified as follows.

**Step 1:** In the DCViewer installation window, click on <Next> to start the installation.

**Step 2:** The status bar will show the installation progress. After the installation is completed, click on <Finish> to exit the installation process.

**Step 3:** Click on <Finish> to close the DCViewer installation page.

Once the Viewer is successfully installed, the Home page of the IP camera will be shown as the figure below.

### Vari-focal Lens Models

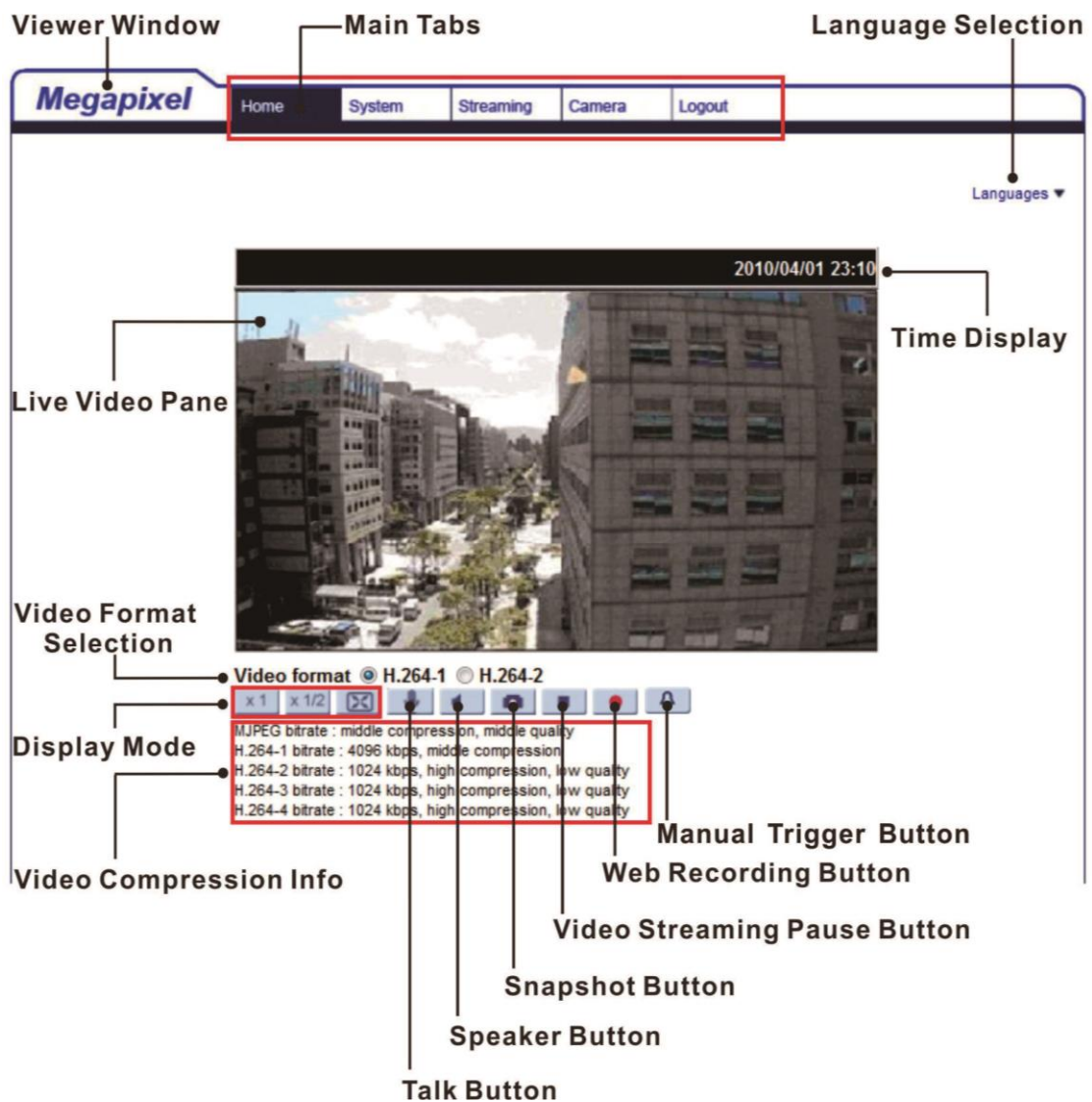

## Motorized Lens Models

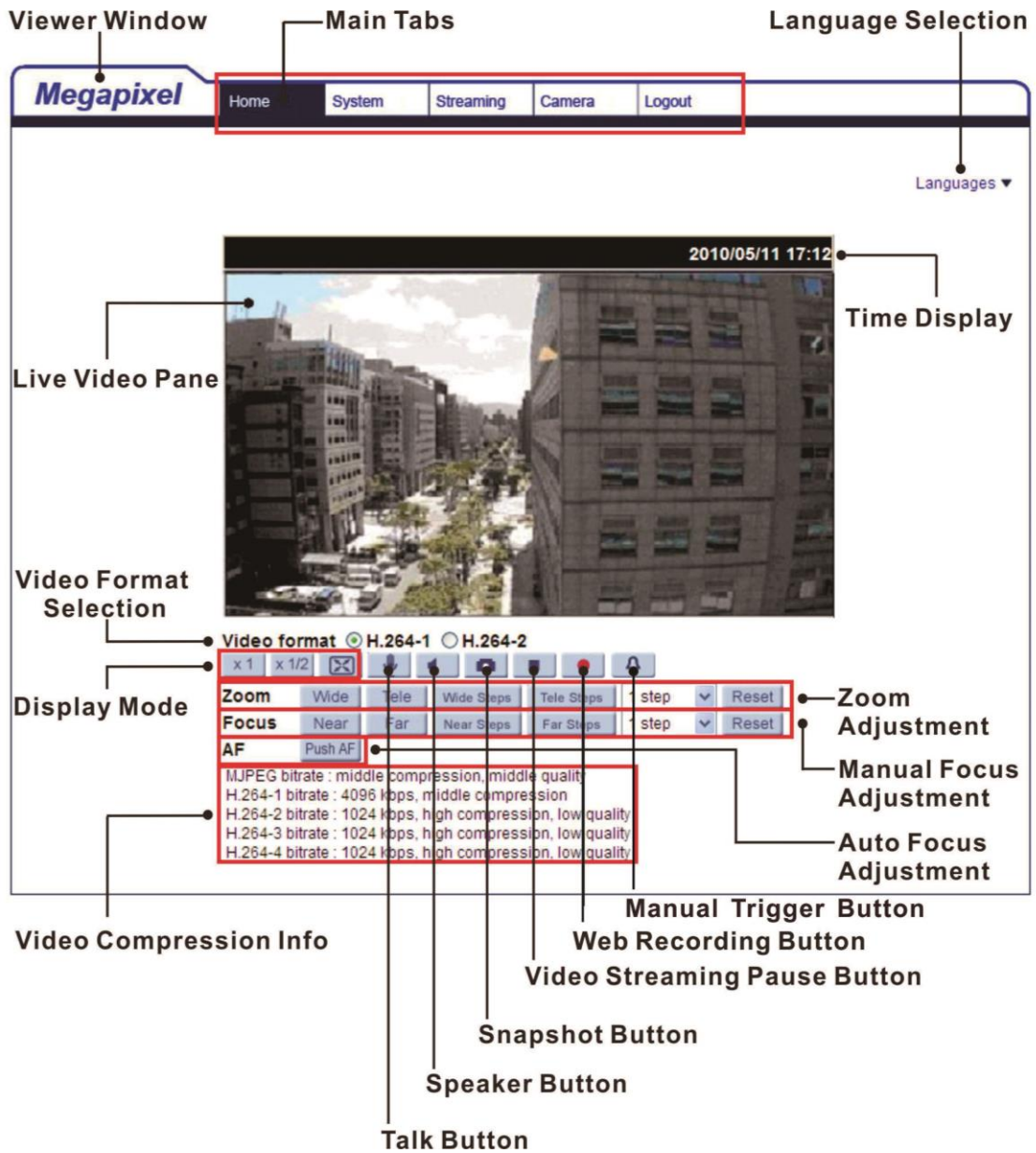



### 3x AF Lens Models

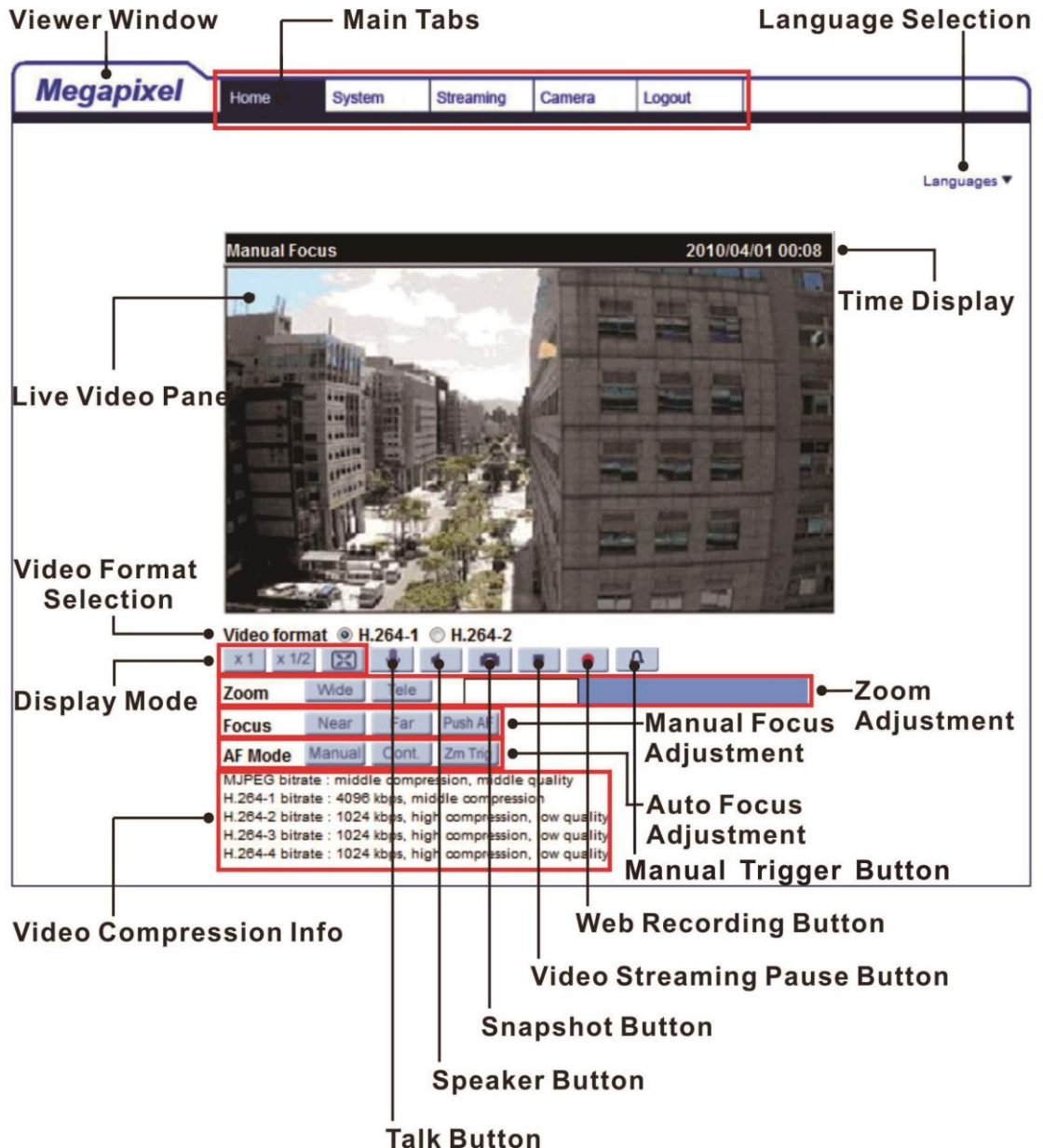

**NOTE:** For details about the function buttons on the Home page, please refer to the [Full HD Multi-Streams Ultra-WDR IP Camera Menu Tree](#) in the supplied CD.

### **Zoom and Focus Adjustment (Motorized Lens / 3x AF Lens Models)**

The live image will be displayed on the Home page when the camera is successfully accessed. If zoom or focus is not at the desired position, please use the function buttons on the Home page for adjustment. Refer to the [Full HD Multi-Streams Ultra-WDR IP Camera Menu Tree](#) in the supplied CD for more details about the function buttons.

### **Zoom and Focus Adjustment (Vari-focal Lens Models)**

For **vari-focal lens** models, zoom and focus can be adjusted by the adjustment bars on the camera lens inside the dome cover. To adjust zoom and focus, please detach the dome cover first. For indoor models, use a plus screw driver to loosen the two screws of the camera. For outdoor models, use the supplied security torx to loosen the two security screws of the camera. Detach the dome cover. Then use the zoom adjustment bar and the focus adjustment bar (positions shown in the following figure) to adjust zoom and focus.

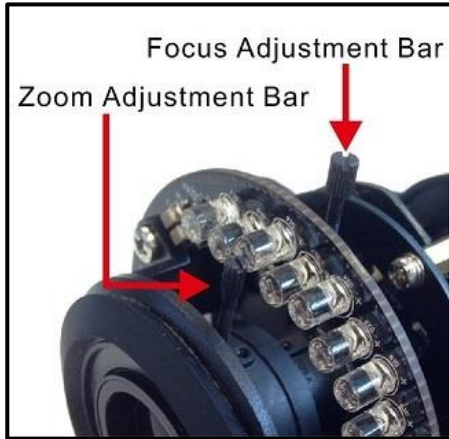

## 5. Setup Video Resolution

Users can setup video resolution on the Video Format page of the user-friendly browser-based configuration interface.

Video Format can be found under this path: **Streaming> Video Format**.

The default values of video resolution are as below.

|             |  |
|-------------|--|
| <b>1.3M</b> | H.264- 1280 x 720 (60/50 fps) + H.264- 1280 x 720 (60/50 fps)                      |
| <b>2M</b>   | H.264- 1920 x 1080 (60/50 fps) +<br>H.264- 720 x 480 (30 fps) / 720 x 576 (50 fps) |

For more details about the combinations of video resolution, please refer to the [Full HD Multi-Streams Ultra-WDR IP Camera Menu Tree](#) in the supplied CD.

## 6. Configuration Files Export / Import

To export / import configuration files, users can access the Maintenance page on the user-friendly browser-based configuration interface.

The Maintenance setting can be found under this path: **System> Maintenance**.

Users can export configuration files to a specified location and retrieve data by uploading an existing configuration file to the camera. This is especially convenient to make multiple cameras having the same configuration.

### **Export**

Users can save the system settings by exporting the configuration file (.bin) to a specified location for future use. Click on the <Export> button, and the popup File Download window will come out. Click on <Save> and specify a desired location for saving the configuration file.

### **Upload**

To upload a configuration file to the camera, click on <Browse> to select the configuration file, and then click on the <Upload> button for uploading.

## 7. Tech Support Information

This chapter will introduce how to delete previously-installed DCViewer in the PC and how to setup the Internet security.

### 7.1 Delete the Existing DCViewer

For users who have installed the DCViewer in the PC previously, please remove the existing DCViewer from the PC before accessing to the IP camera.

#### **Deleting the DCViewer**

In the Windows <Start Menu>, activate <Control Panel>, and then double click on <Add or Remove Programs>. In the <Currently installed programs> list, select <DCViewer> and click on the button <Remove> to uninstall the existing DCViewer.

#### **Deleting Temporary Internet Files**

To improve browser performance, it is suggested to clean up all the files in the Temporary Internet Files. The procedure is as follows.

**Step 1:** In the web browser, clicks on the <Tools> tab on the menu bar and select <Internet Options>.

**Step 2:** Click on the <Delete> button under <Browsing history> section. In the appeared window tick the box beside the <Temporary Internet files>.

**Step 3:** Click on <Delete> to start deleting the files.

## 7.2 Setup Internet Security

If ActiveX control installation is blocked, please either set Internet security level to default or change ActiveX controls and plug-ins settings.

### **Internet Security Level: Default**

**Step 1:** Start the Internet Explorer (IE).

**Step 2:** Click on the <Tools> tab on the menu bar and select <Internet Options>.

**Step 3:** Click on the <Security> tab, and select <Internet> zone.

**Step 4:** Down the page, click on the <Default Level> button and click on <OK> to confirm the setting. Close the browser window, and restart a new one later to access the camera.

### **ActiveX Controls and Plug-ins Settings**

**Step 1:** Repeat **Step 1 to Step 3** of the previous section above.

**Step 2:** Down the page, click on the <Custom Level> button to change ActiveX controls and plug-ins settings. The Security Settings window will pop up.

**Step 3:** Under <ActiveX controls and plug-ins>, set **ALL** items (as listed below) to <Enable> or <Prompt>. Please note that the items vary by IE version.

#### **ActiveX controls and plug-ins settings:**

1. Binary and script behaviors.
2. Download signed ActiveX controls.
3. Download unsigned ActiveX controls.
4. Allow previously unused ActiveX controls to run without prompt.
5. Allow Scriptlets.
6. Automatic prompting for ActiveX controls.
7. Initialize and script ActiveX controls not marked as safe for scripting.
8. Run ActiveX controls and plug-ins.
9. Only allow approved domains to use ActiveX without prompt.
10. Script ActiveX controls marked safe for scripting\*.
11. Display video and animation on a webpage that does not use external media player.

**Step 4:** Click on <OK> to accept the settings. A prompt window will appear for confirming the setting changes, click <Yes(Y)> to close the Security Setting window.

**Step 5:** Click on <OK> to close the Internet Options screen.

**Step 6:** Close the browser window, and restart a new one later to access the IP Camera.